

The STIHL logo is displayed in white, bold, italicized capital letters on an orange rectangular background in the top right corner of the cover.

STIHL

A commemorative logo for STIHL's 100th anniversary. It features the number '100' in a large, stylized font with a wood-grain texture, the word 'YEARS' below it, and the dates '1926-2026' at the bottom, all within a white rectangular frame.

100
YEARS
1926-2026

STIHL PRICE BOOK

VALID FROM 2ND MARCH 2026

BATTERY TOOLS

Battery Chainsaws for Cutting Firewood & Property Maintenance	4 - 5
Battery Chainsaw for Arborist Work	5
Battery Pole Pruners	6
Battery Cut-off Machines	6
Battery Grass Trimmers for Home Use	7
Battery Brushcutters for Long Grass & Landscape Maintenance	8
Battery Blowers	9 - 10
Battery Vacuum Shredder	10
Battery KombiEngines	11
Battery Pruners & Trimmers for Home Use	11
Battery Pruner & Trimmer Accessories	11
Battery Hedge Trimmers for Home Use	12
Battery Hedge Trimmers for Professional Use	12
Battery Sweeper	13
Battery Scarifier	13
Long-Reach Battery Hedge Trimmers	13
Battery Sprayer	13
Portable Power Supply	13
Battery Vacuums & Pressure Washers	14
Battery Compressor	14
Battery Lawn Mowers	15
Next Gen iMow Robotic Lawn Mowers & Accessories	16
iMow Robotic Lawn Mowers & Accessories	17
Battery Accessories	18 - 19
Batteries & Chargers	20
Guide to Battery Run Times	21 - 23

CHAINSAWS & POLE PRUNERS

Electric Chainsaws	24
Petrol Chainsaws for Cutting Firewood & Property Maintenance	24 - 25
Petrol Chainsaws for Agriculture & Horticulture	26
Petrol Chainsaws for Forestry Work	27 - 28
Petrol Chainsaws for Arborist Work	29
Petrol Chainsaw for Emergency Service	29
Petrol Pole Pruners	29
Guide to Chainsaws & Pole Pruners	30 - 33
Chain Loops	34 - 36
Chain Loops for Professional Use	36

Hexa Chain & Kits	37
Chain Reels	37 - 39
Chain Reels for Professional Use	40
Chain Loops to Suit Non-STIHL Chainsaws	40 - 41
Chain Spares	41 - 42
Guide Bars & Spur Sprocket for Carving Guide Bars	42 - 44
Scabbards, File Systems & File Guides	45 - 46
Chain Sharpening	47 - 49
Chain Breakers & Rivet Spinners	49
Chainsaw & Pole Pruner Accessories	50
Forestry Accessories	51

GRASS TRIMMERS

Electric & Petrol Grass Trimmers for Home Use	52
Petrol Brushcutters for Home Use	52
Petrol Brushcutters for Long Grass & Landscape Maintenance	52 - 54
Harnesses	54 - 55
Nylon Lines	55 - 57
Grass Trimmer, Brushcutter Accessories	57 - 59
Guide to Grass Trimmers & Brushcutters	60 - 61
Guide to Mowing Heads	62 - 63
Guide to Metal Cutting Tools	64

BLOWERS & VACUUM SHREDDERS

Electric Blowers for Home Use	65
Petrol Blowers - Handheld	65
Petrol Backpack Blowers	65
Electric Vacuum Shredders	66
Petrol Vacuum Shredders	66
Blower & Vacuum Shredders Accessories	66 - 67
Guide to Blowers & Shredders	68 - 69

HEDGE TRIMMERS

Electric Hedge Trimmers for Home Use	70
Petrol Hedge Trimmers for Home Use	71
Petrol Hedge Trimmers for Professional Use	72

KOMBISYSTEMS & MULTISYSTEM

Petrol KombiEngines	73
KombiTools & Accessories	74 - 75
Petrol MultiEngine	76
MultiTool Attachments	76

GARDEN SHREDDERS

Electric Garden Shredders	77
---------------------------	----

HIGH-PRESSURE CLEANERS

Electric High-pressure Cleaners	78 - 79
---------------------------------	---------

Electric High-pressure Cleaner Accessories	80
--	----

Petrol High-pressure Cleaners	81
-------------------------------	----

Petrol High-pressure Cleaner Accessories	82
--	----

VACUUMS

Electric Vacuum Cleaners	83
--------------------------	----

Vacuum Cleaner Accessories	83 - 84
----------------------------	---------

SPRAYERS

Petrol Mistblower & Accessories	85
---------------------------------	----

Manual Sprayers	85
-----------------	----

Manual Sprayer Accessories	86
----------------------------	----

SWEEPERS

Manual Sweepers	87
-----------------	----

AUGERS

Petrol Drill & Accessories	88
----------------------------	----

Planting Augers	88
-----------------	----

Petrol Auger	89
--------------	----

Petrol Auger Accessories	89 - 92
--------------------------	---------

Guide to Auger & Drill	92
------------------------	----

CUT-OFF MACHINES

Petrol Cut-off Chainsaw & Accessories	93
---------------------------------------	----

Petrol Cut-off Machines	94
-------------------------	----

Cut-off Machine Accessories	95
-----------------------------	----

Cut-off Machine Wheels	96
------------------------	----

Guide to Cutting Wheels	97
-------------------------	----

SERVICE KITS

Service Kits & Smart Connect	98 - 100
------------------------------	----------

FUELS & OILS

Fuels & 2-Stroke Oils	101
-----------------------	-----

Bar & Chain Oils & Accessories	102
--------------------------------	-----

Canisters, Lubes, Cleaners & Additive	103
---------------------------------------	-----

PERSONAL PROTECTIVE EQUIPMENT

Chainsaw Protective Pants & Chaps	104
-----------------------------------	-----

Work Pants	105
------------	-----

Protective Inserts	105
--------------------	-----

Belts, Braces & Trousers	105
--------------------------	-----

Guide to Pants & Chaps	106 - 107
------------------------	-----------

Clothing	108
----------	-----

Eye Protection & Gloves	109
-------------------------	-----

Guide to Gloves	110
-----------------	-----

Helmets, Face & Ear Protection	111 - 112
--------------------------------	-----------

HAND TOOLS

Shears & Trimmer	113
------------------	-----

Secateurs	114
-----------	-----

Pruning Saws	114
--------------	-----

Axes	115
------	-----

Forestry Tools	115
----------------	-----

MERCHANDISE

STIHL TIMBERSPORTS® & STIHL Branded Merchandise	116 - 123
---	-----------

TRADING INFORMATION & WARRANTY

Trading Information	124
---------------------	-----

Warranty Terms	125
----------------	-----

New Guide Bar Design	126
----------------------	-----

Notes	127
-------	-----



i **DIGITAL PRICE BOOK**

To save the latest price book to your device, simply scan the QR code to download it.

Any updates made will automatically be uploaded to the price book in this link.

BATTERY CHAINSAWS FOR CUTTING FIREWOOD & PROPERTY MAINTENANCE



**MSA 60 C-B
30CM/12"
KIT***

Supplied with AL 101 charger & AK 20 battery



WEIGHT (KG)	ORDER NUMBER	MIN ORDER	RRP INC. GST
3.7 [†]	MA04 011 5870	1	\$549.00

REPLACEMENT CHAIN LOOP PM3 - 1/4" .043" - 64DL - 30CM/12"	3670 000 0064	1	\$46.00
---	---------------	---	---------

REPLACEMENT GUIDE BAR 1/4" .043" - 30CM/12" - ROLLOMATIC MINI	3005 008 3405	1	\$62.00
---	---------------	---	---------

SKIN ONLY	2.9*	MA04 011 5800	1	\$399.00
------------------	------	---------------	---	----------

**MSA 70 C-B
30CM/12"
KIT***

Supplied with AL 101 charger & AK 30 battery



3.9 [†]	MA04 011 5886	1	\$679.00
------------------	---------------	---	----------

REPLACEMENT CHAIN LOOP PM3 - 1/4" .043" - 64DL - 30CM/12"	3670 000 0064	1	\$46.00
---	---------------	---	---------

REPLACEMENT GUIDE BAR 1/4" .043" - 30CM/12" - ROLLOMATIC MINI	3005 008 3405	1	\$62.00
---	---------------	---	---------

SKIN ONLY	2.9*	MA04 011 5816	1	\$499.00
------------------	------	---------------	---	----------

**MSA 80 C-B
35CM/14"
KIT***

Supplied with AL 101 charger & AK 30 S battery



4.6 [†]	MA04 011 5839	1	\$729.00
------------------	---------------	---	----------

REPLACEMENT CHAIN LOOP PM3 - 1/4" .043" - 72DL - 35CM/14"	3670 000 0072	1	\$54.00
---	---------------	---	---------

REPLACEMENT GUIDE BAR 1/4" .043" - 35CM/14" - ROLLOMATIC MINI	3005 008 3409	1	\$72.00
---	---------------	---	---------

SKIN ONLY	3.3*	MA04 011 5843	1	\$549.00
------------------	------	---------------	---	----------



**MSA 160 C-B
30CM/12"
SKIN***



3.1*	MA03 200 0004	1	\$499.00
------	---------------	---	----------

REPLACEMENT CHAIN LOOP PM3 - 1/4" .043" - 64DL - 30CM/12"	3670 000 0064	1	\$46.00
---	---------------	---	---------

REPLACEMENT GUIDE BAR 1/4" .043" - 30CM/12" - ROLLOMATIC MINI	3005 008 3405	1	\$62.00
---	---------------	---	---------

**MSA 200 C-B
35CM/14"
SKIN***



3.3*	MA03 200 0010	1	\$599.00
------	---------------	---	----------

REPLACEMENT CHAIN LOOP PM3 - 1/4" .043" - 72DL - 35CM/14"	3670 000 0072	1	\$54.00
---	---------------	---	---------

REPLACEMENT GUIDE BAR 1/4" .043" - 35CM/14" - ROLLOMATIC MINI	3005 008 3409	1	\$72.00
---	---------------	---	---------

**MSA 220 C-B
35CM/14"
SKIN***



3.6*	MA03 200 0020	1	\$689.00
------	---------------	---	----------

REPLACEMENT CHAIN LOOP PS3 - 3/8"P - .043" - 50DL - 35CM/14"	3699 000 0050	1	\$36.00
--	---------------	---	---------

REPLACEMENT GUIDE BAR L04 35CM/14" 1.1MM/.043" 3/8"	3005 000 4409	1	\$75.00
---	---------------	---	---------

**MSA 220 C-B
40CM/16"
SKIN***



3.7*	MA03 200 0021	1	\$699.00
------	---------------	---	----------

REPLACEMENT CHAIN LOOP PS3 - 3/8"P - .043" - 55DL - 40CM/16"	3699 000 0055	1	\$42.00
--	---------------	---	---------

REPLACEMENT GUIDE BAR L04 40CM/16" 1.1MM/.043" 3/8"	3005 000 4413	1	\$83.00
---	---------------	---	---------





*WEIGHT EXCLUDING BATTERY

#WEIGHT EXCLUDING BATTERY, GUIDE BAR & CHAIN







*WEIGHT INCLUDING BATTERY

*BAR DESIGN MAY DIFFER TO MODEL SHOWN

BATTERY CHAINSAWS FOR CUTTING FIREWOOD & PROPERTY MAINTENANCE

		WEIGHT (KG)	ORDER NUMBER	MIN ORDER	RRP INC. GST
MSA 300 C-O 40CM/16" SKIN[^] 		5.4*	MA02 200 0024	1	\$1,289.00
	REPLACEMENT CHAIN LOOP 23RS - .325" - 1.3MM - 67DL - 40CM/16"		3690 000 0067	1	\$48.00
	REPLACEMENT GUIDE BAR 40CM/16" - 1.3MM/.050" - LIGHT 04		3003 000 3313	1	\$90.00
MSA 300 C-O 40CM/16" SC2A INCLUDED SKIN[^] 		5.4*	MA02 200 0062	1	\$1,349.00
	REPLACEMENT CHAIN LOOP 23RS - .325" - 1.3MM - 67DL - 40CM/16"		3690 000 0067	1	\$48.00
	REPLACEMENT GUIDE BAR 40CM/16" - 1.3MM/.050" - LIGHT 04		3003 000 3313	1	\$90.00
MSA 300 C-O 45CM/18" SKIN[^] 		5.4*	MA02 200 0027	1	\$1,299.00
	REPLACEMENT CHAIN LOOP 23RS - .325" - 1.3MM - 74DL - 45CM/18"		3690 000 0074	1	\$50.00
	REPLACEMENT GUIDE BAR 45CM/18" - 1.3MM/.050" - LIGHT 04		3003 008 3317	1	\$100.00
MSA 300 C-O 50CM/20" SKIN[^] 		5.4*	MA02 200 0029	1	\$1,309.00
	REPLACEMENT CHAIN LOOP 23RS - .325" - 1.3MM - 81DL - 50CM/20"		3690 000 0081	1	\$54.00
	REPLACEMENT GUIDE BAR 50CM/20" - 1.3MM/.050" - LIGHT 04		3003 008 3321	1	\$110.00

BATTERY CHAINSAW FOR ARBORIST WORK

		WEIGHT (KG)	ORDER NUMBER	MIN ORDER	RRP INC. GST
MSA 161 T 30CM/12" SKIN[^] 		2.1#	1252 200 0044	1	\$799.00
	REPLACEMENT CHAIN LOOP PM3 - 1/4" .043" - 65DL - 30CM/12"		3670 000 0065	1	\$51.00
	REPLACEMENT GUIDE BAR 1/4" .043" - 30CM/12" - ROLLOMATIC MINI		3005 008 3405	1	\$62.00
NEW MSA 190 T 30CM/12" SKIN[^] 		2.6#	MA05 200 0042	1	\$799.00
	REPLACEMENT CHAIN LOOP PS3 - 3/8"P - .043" - 44DL - 30CM/12"		3699 000 0044	1	\$36.00
	REPLACEMENT GUIDE BAR 30CM/12" - 1.1MM/.043" 3/8" - LIGHT 01		3005 008 3905	1	\$62.00
MSA 220 T 30CM/12" SKIN[^] 		2.7#	MA01 200 0044	1	\$849.00
	REPLACEMENT CHAIN LOOP PS3 - 3/8"P - .043" - 44DL - 30CM/12"		3699 000 0044	1	\$36.00
	REPLACEMENT GUIDE BAR 30CM/12" - 1.1MM/.043" 3/8" - LIGHT 04		3005 000 4405	1	\$70.00
MSA 220 T 35CM/14" SKIN[^] 		2.7#	MA01 200 0045	1	\$859.00
	REPLACEMENT CHAIN LOOP PS3 - 3/8"P - .043" - 50DL - 35cm/14"		3699 000 0050	1	\$36.00
	REPLACEMENT GUIDE BAR 35CM/14" - 1.1MM/.043" 3/8" - LIGHT 04		3005 000 4409	1	\$75.00
MSA 220 TC-O 30CM/12" SKIN[^] 		2.7#	MA01 200 0046	1	\$879.00
	REPLACEMENT CHAIN LOOP PS3 - 3/8"P - .043" - 44DL - 30CM/12"		3699 000 0044	1	\$36.00
	REPLACEMENT GUIDE BAR 30CM/12" - 1.1MM/.043" 3/8" - LIGHT 04		3005 000 4405	1	\$70.00
MSA 220 TC-O 35CM/14" SKIN[^] 		2.7#	MA01 200 0047	1	\$889.00
	REPLACEMENT CHAIN LOOP PS3 - 3/8"P - .043" - 50DL - 35CM/14"		3699 000 0050	1	\$36.00
	REPLACEMENT GUIDE BAR 30CM/14" - 1.1MM/.043" 3/8" - LIGHT 04		3005 000 4409	1	\$75.00

*WEIGHT EXCLUDING BATTERY

#WEIGHT EXCLUDING BATTERY, GUIDE BAR & CHAIN

*BAR DESIGN MAY DIFFER TO MODEL SHOWN

BATTERY POLE PRUNERS



AVAILABLE Q2
HTA 30
20CM/8"
SKIN[^]



	WEIGHT (KG)	ORDER NUMBER	MIN ORDER	RRP INC. GST
	3.2*	LA05 011 6400	1	\$399.00
REPLACEMENT CHAIN LOOP PM3 - 1/4" .043" - 44DL - 20CM/8"		3670 000 0044	1	\$TBC
REPLACEMENT GUIDE BAR LO1 1/4" .043" 20CM/8		3008 000 0203	1	\$TBC



HTA 50
25CM/10"
SKIN[^]



	3.6*	LA02 011 6400	1	\$399.00
REPLACEMENT CHAIN LOOP PM3 - 1/4" .043" - 56DL - 25CM/10"		3670 000 0056	1	\$40.00
REPLACEMENT GUIDE BAR 1/4" .043" - 25CM/10" - ROLLOMATIC MINI		3005 008 3403	1	\$46.00
HTA 50 - EXTENSION SHAFT 50CM	0.5	LA02 820 5000	1	\$65.00



HTA 86
30CM/12"
SKIN[^]

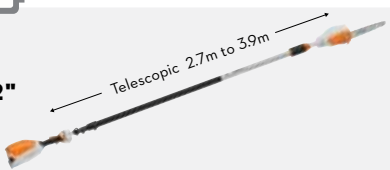

	4.6*	LA03 200 0002	1	\$899.00
REPLACEMENT CHAIN LOOP PM3 - 1/4" .043" - 64DL - 30CM/12"		3670 000 0064	1	\$46.00
REPLACEMENT GUIDE BAR 1/4" .043" - 30CM/12" - ROLLOMATIC MINI		3005 008 3405	1	\$62.00

HTA 135
30CM/12"
SKIN[^]



	6.8*	LA01 200 0044	1	\$999.00
REPLACEMENT CHAIN LOOP PM3 - 1/4" .043" - 64DL - 30CM/12"		3670 000 0064	1	\$46.00
REPLACEMENT GUIDE BAR 1/4" .043" - 30CM/12" - ROLLOMATIC MINI		3005 008 3405	1	\$62.00

HTA 160
30CM/12"
SKIN[^]



	6.9*	LA01 200 0033	1	\$1,199.00
REPLACEMENT CHAIN LOOP PM3 - 1/4" .043" - 64DL - 30CM/12"		3670 000 0064	1	\$46.00
REPLACEMENT GUIDE BAR 1/4" .043" - 30CM/12" - ROLLOMATIC MINI		3005 008 3405	1	\$62.00

BATTERY CUT-OFF MACHINE



TSA 230
230MM/9" SKIN
 (Supplied with KM-E steel abrasive wheel as standard)



WEIGHT (KG)	ORDER NUMBER	MIN ORDER	RRP INC. GST
3.9*	4864 011 6620	1	\$899.00

DEPTH LIMITER
 (for use with TSA 230)



DEPTH LIMITER & VACUUM ATTACHMENT POINT FOR DRY CUTTING.

4864 690 0801	1	\$181.00
---------------	---	----------

TSA 300
300MM/12" SKIN
 (Supplied with KM-E steel abrasive wheel as standard)



8.3*	TA02 011 6606	1	\$1,499.00
------	---------------	---	------------

DEPTH LIMITER
 (for use with TSA 300)



DEPTH LIMITER & VACUUM ATTACHMENT POINT FOR DRY CUTTING.

TA02 690 0800	1	\$349.00
---------------	---	----------

*WEIGHT EXCLUDING BATTERY

#WEIGHT EXCLUDING BATTERY, GUIDE BAR & CHAIN

*BAR DESIGN MAY DIFFER TO MODEL SHOWN

BATTERY GRASS TRIMMERS FOR HOME USE



**FSA 30
POLYCUT 3-2 KIT**
Supplied with AL 1 charger
& AS 2 battery



SKIN
ONLY

WEIGHT (KG)	ORDER NUMBER	MIN ORDER	RRP INC. GST
2.3	FA10 011 5713	1	\$259.00

2.1*	FA10 011 5700	1	\$179.00
------	---------------	---	----------



**NEW
FSA 50
AUTOCUT C 3-2
KIT**
Supplied with AL 101
charger & AK 10 battery



SKIN
ONLY

3.7	FA11 011 5719	1	\$399.00
-----	---------------	---	----------

2.9*	FA11 011 5700	1	\$269.00
------	---------------	---	----------

**FSA 57
AUTOCUT C 3-2
KIT**
(While stocks last)
Supplied with AL 101
charger & AK 10 battery



SKIN
ONLY

3.5	4522 011 5744	1	\$459.00
-----	---------------	---	----------

2.7*	4522 011 5730	1	\$329.00
------	---------------	---	----------

**FSA 70 R
AUTOCUT C 12-2
KIT**
Supplied with AL 101
charger & AK 20 battery



SKIN
ONLY

4.7	FA07 011 5715	1	\$549.00
-----	---------------	---	----------

3.5*	FA07 011 5700	1	\$399.00
------	---------------	---	----------

**FSA 80 R
AUTOCUT 27-2
KIT**
Supplied with AL 101
charger & AK 30 battery



SKIN
ONLY

6.0	FA08 011 5734	1	\$679.00
-----	---------------	---	----------

4.8*	FA08 011 5720	1	\$499.00
------	---------------	---	----------

*WEIGHT EXCLUDING BATTERY

BATTERY BRUSHCUTTERS FOR LONG GRASS & LANDSCAPE MAINTENANCE



WEIGHT (KG) ORDER NUMBER MIN ORDER RRP INC. GST

**FSA 110 R
AUTOCUT C 12-2
SKIN**



3.6*

FA07 011 5720

1

\$449.00

**FSA 120 R
AUTOCUT 27-2
SKIN**



4.6*

FA08 200 0005

1

\$699.00

**FSA 120
AUTOCUT 27-2
SKIN**



4.8*

FA08 200 0002

1

\$749.00

**FSA 135 R
AUTOCUT C 26-2
SKIN**



4.3*

FA01 200 0029

1

\$799.00

**FSA 135
AUTOCUT C 26-2
SKIN**



4.9*

FA01 200 0025

1

\$849.00

**FSA 200 R
AUTOCUT 26-2
SKIN**



4.9*

FA03 200 0007

1

\$899.00

**FSA 200
AUTOCUT 26-2
SKIN**



5.8*

FA03 200 0000

1

\$949.00

**FSA 400
BRUSH KNIFE
300-3
SKIN**



7.0*

FA09 200 0014

1

\$1,399.00

*WEIGHT EXCLUDING BATTERY

*NO LONGER AVAILABLE TO ORDER

BATTERY BLOWERS FOR HOME USE



BGA 30 KIT

Supplied with AL 1 charger & 2x AS 2 batteries



	AIR THROUGHPUT (M ³ /H)	MAX AIR SPEED (KM/H)	WEIGHT (KG)	ORDER NUMBER	MIN ORDER	RRP INC. GST
	380	144	1.8 [†]	BA08 011 5916	1	\$259.00

SKIN ONLY	380	144	1.58 [*]	BA08 011 5900	1	\$179.00
------------------	-----	-----	-------------------	---------------	---	----------



BGA 50 KIT

Supplied with AL 101 charger & AK 20 battery



	770	198	3.5 [†]	BA05 011 5912	1	\$479.00
--	-----	-----	------------------	---------------	---	----------

SKIN ONLY	770	198	2.3 [*]	BA05 011 5900	1	\$329.00
------------------	-----	-----	------------------	---------------	---	----------

BGA 60 KIT

Supplied with AL 101 charger & AK 30 S battery



	780	248	3.5 [†]	BA04 011 5944	1	\$629.00
--	-----	-----	------------------	---------------	---	----------

SKIN ONLY	780	248	2.3 [*]	BA04 011 5900	1	\$449.00
------------------	-----	-----	------------------	---------------	---	----------

BATTERY BLOWERS FOR PROFESSIONAL USE



BGA 86 SKIN



	AIR THROUGHPUT (M ³ /H)	MAX AIR SPEED (KM/H)	WEIGHT (KG)	ORDER NUMBER	MIN ORDER	RRP INC. GST
	780	248	2.8 [*]	BA02 011 5900	1	\$449.00

BGA 100 SKIN

(Battery connection by cable required)



	840	270 [^]	2.5 [*]	4866 011 5900	1	\$599.00
--	-----	------------------	------------------	---------------	---	----------

BGA 160 SKIN







	970	273 [^]	2.6 [*]	BA09 011 5900	1	\$499.00
--	-----	------------------	------------------	---------------	---	----------

*WEIGHT EXCLUDING BATTERY

[†]WEIGHT INCLUDING BATTERY

[^]IN BOOST

BATTERY BLOWERS FOR PROFESSIONAL USE CONTINUED

APIII SYSTEM		AIR THROUGHPUT (M ³ /H)	MAX AIR SPEED (KM/H)	WEIGHT (KG)	ORDER NUMBER	MIN ORDER	RRP INC. GST
BGA 200 SKIN (Battery connection by cable required)		940	302 [^]	3.2 [*]	BA01 011 5900	1	\$749.00
	BGA 200 SET INCLUDING HIP PAD KIT				BA01 200 0000	1	\$850.00
	HIP PAD KIT ONLY INCLUDING L HOOK				BA01 490 0400	1	\$148.00
BGA 250 SKIN		1044	305 [^]	2.7 [*]	BA06 011 5900	1	\$599.00
BGA 300 SKIN Requires AR L battery or ADA 1000 to use AP batteries (Not included)		970	309	7.4 [*]	BA03 011 5910	1	\$999.00
AVAILABLE Q2 BRA 600 SKIN		1,500	406	10.5 [*]	BA07 011 5910	1	\$1,649.00

BATTERY VACUUM SHREDDER



AKIII SYSTEM		AIR THROUGHPUT VAC MODE (M ³ /H)	CATCHER BAG	WEIGHT (KG)	ORDER NUMBER	MIN ORDER	RRP INC. GST
SHA 56 SKIN		510	40L	3.2 [*]	SA02 011 7100	1	\$349.00
SHOULDER MOUNTED CATCHER BAG KIT FOR SHA 56					SA02 007 1000	1	\$143.00
SHA 140 SKIN		910	55L	5.1 [*]	SA07 011 7100	1	\$499.00
CATCHER BAG COVER FOR SHA 140					SA07 820 4800	1	\$139.00

*WEIGHT EXCLUDING BATTERY





**WEIGHT INCLUDING BATTERY

*IN BOOST

BATTERY KOMBIENGINES

		WEIGHT (KG)	ORDER NUMBER	MIN ORDER	RRP INC. GST
AKII SYSTEM					
KMA 80 R SKIN		3.1*	FA08 011 6800	1	\$449.00
APIII SYSTEM					
KMA 135 R SKIN		3.4*	FA02 011 6810	1	\$649.00
KMA 200 R SKIN		3.9*	FA03 011 6800	1	\$699.00

BATTERY PRUNERS & TRIMMERS FOR HOME USE

		WEIGHT (KG)	ORDER NUMBER	MIN ORDER	RRP INC. GST
ASII SYSTEM					
ASA 20 KIT Supplied with AS 2 battery, AL 1 charger & scabbard		0.76*	VA05 011 6213	1	\$329.00
	SKIN ONLY		VA05 011 6200	1	\$249.00
	REPLACEMENT BLADE		VA05 007 4200	1	\$37.50
GTA 26 KIT PRUNER 10CM/4" Supplied with AS 2 battery, AL 1 charger, 10cm light guide bar, 10cm 1/4" PM3 saw chain, Bio Multi-use Oil 50ml & carry case		1.2*	GA01 011 6915	1	\$279.00
	REPLACEMENT CHAIN LOOP PM3 - 1/4" .043" 28 DL 10CM/4"		3670 000 0028	1	\$25.00
	REPLACEMENT GUIDE BAR 1/4" .043" 10CM/4" ROLLOMATIC LIGHT		3007 003 0101	1	\$24.00
	SKIN ONLY		GA01 011 6905	1	\$199.00
GTA 40 KIT PRUNER 15CM/6" Supplied with 2x AS 2 batteries, AL 5-2 charger, 15cm light guide bar, 15cm 1/4" PM3 saw chain & carry case		1.4*	GA04 011 6915	1	\$569.00
	REPLACEMENT CHAIN LOOP PM3 - 1/4" .043" 38 DL 15CM/6"		3670 000 0038	1	\$32.00
	REPLACEMENT GUIDE BAR 1/4" .043" 15CM/6" LIGHT 01		3008 000 0202	1	\$38.00
	SKIN ONLY		GA04 011 6900	1	\$399.00
HSA 26 KIT Supplied with carry case, AS 2 battery, AL 1 charger, grass blade & shrub blade		0.7*	HA03 011 3510	1	\$249.00
	REPLACEMENT SHRUB BLADE		HA03 820 3000	1	\$41.60
	REPLACEMENT GRASS BLADE		HA03 820 3500	1	\$41.60
	SKIN ONLY		HA03 011 3504	1	\$169.00

BATTERY PRUNER & TRIMMER ACCESSORIES

		WEIGHT (KG)	ORDER NUMBER	MIN ORDER	RRP INC. GST
GTA 26 EXTENSION SHAFT		1.3 KG^	GA01 820 5000	1	\$165.00
HSA 26 EXTENSION SHAFT Includes wheel kit Not suitable to use with GTA 26 or HSA 25		0.6^	HA03 710 7100	1	\$113.00

*WEIGHT EXCLUDING BATTERY

BATTERY HEDGE TRIMMERS FOR HOME USE



HSA 30
45CM/18" KIT
 Supplied with AL 1 charger & AS 2 battery



WEIGHT (KG)	ORDER NUMBER	MIN ORDER	RRP INC. GST
2.0*	HA08 011 3513	2	\$279.00

SKIN ONLY	2.0*	HA08 011 3500	2	\$179.00
-----------	------	---------------	---	----------

HSA 40
50CM/20" KIT
 Supplied with AL 1 charger & 2x AS 2 batteries



2.1*	HA08 011 3533	2	\$329.00
------	---------------	---	----------

SKIN ONLY	2.1*	HA08 011 3520	2	\$209.00
-----------	------	---------------	---	----------

AVAILABLE Q2
HLA 40
45CM SKIN

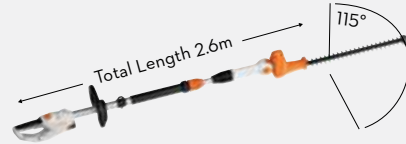

3.5*	HA10 011 2900	1	\$269.00
------	---------------	---	----------



HSA 50
50CM/20" KIT
 Supplied with AL 101 charger & AK 10 battery



2.9*	4521 011 3574	1	\$459.00
------	---------------	---	----------

SKIN ONLY	2.9*	4521 011 3560	1	\$329.00
-----------	------	---------------	---	----------

HSA 60
60CM/24" KIT
 Supplied with AL 101 charger & AK 10 battery



3.5*	HA06 011 3514	1	\$559.00
------	---------------	---	----------

SKIN ONLY	3.5*	HA06 011 3530	1	\$429.00
-----------	------	---------------	---	----------

HLA 56
45CM/18" SKIN



3.8*	HA01 011 2910	1	\$349.00
------	---------------	---	----------

HLA 56 EXTENSION SHAFT 50CM	0.5	HA01 820 5000	1	\$77.00
-----------------------------	-----	---------------	---	---------

BATTERY HEDGE TRIMMERS FOR PROFESSIONAL USE



HSA 100
60CM SKIN



WEIGHT (KG)	ORDER NUMBER	MIN ORDER	RRP INC. GST
-------------	--------------	-----------	--------------

3.7*	HA07-011-3530	1	\$549.00
------	---------------	---	----------

HSA 130 T
60CM SKIN
 (While stocks last - Battery connection by cable required)

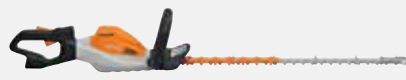

3.9*	4869 011 3566	1	\$849.00
------	---------------	---	----------

HSA 140 T
60CM SKIN



4.2*	HA02 011 3510	1	\$899.00
------	---------------	---	----------

HSA 140 R
75CM SKIN

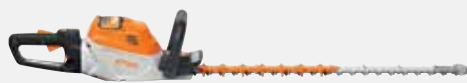

4.3*	HA02 011 3505	1	\$899.00
------	---------------	---	----------

*WEIGHT EXCLUDING BATTERY

*WEIGHT INCLUDING BATTERY

*WEIGHT OF EXTENSION ARM WITHOUT BATTERY & ATTACHMENTS

LONG-REACH BATTERY HEDGE TRIMMERS FOR PROFESSIONAL USE



**HLA 66
50CM SKIN**

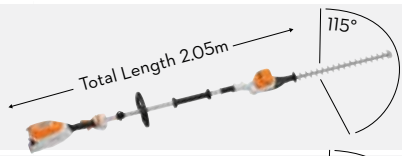

WEIGHT (KG)	ORDER NUMBER	MIN ORDER	RRP INC. GST
-------------	--------------	-----------	--------------

3.7* 4859 011 2910 1 **\$649.00**

**HLA 86
50CM SKIN**

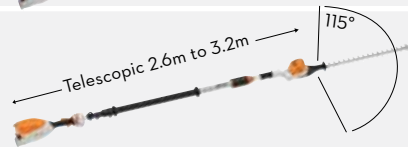

4.8* 4859 011 2930 1 **\$829.00**

**HLA 135 K
50CM SKIN**

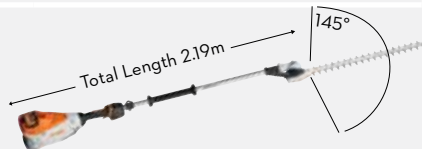

5.2* HA04 200 0005 1 **\$849.00**

**HLA 135
60CM SKIN**

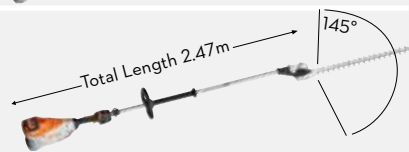

5.6* HA04 200 0016 1 **\$929.00**

BATTERY SPRAYER & ACCESSORY



SGA 85

Recommended battery AP 200



FILL VOLUME	OPERATING PRESSURE	ORDER NUMBER	MIN ORDER	RRP INC. GST
-------------	--------------------	--------------	-----------	--------------

17L 4 - 6 BAR 4854 011 7005 1 **\$699.00**

**WAIST BELT +
SCABBARD FOR
SPRAY LANCE**



4854 710 9100 1 **\$111.00**

PORTABLE POWER SUPPLY



PS 1

(Battery not included)



WEIGHT (KG)	ORDER NUMBER	MIN ORDER	RRP INC. GST
-------------	--------------	-----------	--------------

0.2* GA08 011 8000 1 **\$59.00**

BATTERY SWEEPER



**KGA 770
SKIN**



SWEEPING WIDTH (CM)	CONTAINER VOLUME (L)	WEIGHT (KG)	ORDER NUMBER	MIN ORDER	RRP INC. GST
---------------------	----------------------	-------------	--------------	-----------	--------------

77 50 16.0* 4860 011 4704 1 **\$1,399.00**

BATTERY SCARIFIER



**RLA 240
SKIN**







CUTTING WIDTH	WEIGHT (KG)	ORDER NUMBER	MIN ORDER	RRP INC. GST
---------------	-------------	--------------	-----------	--------------

34CM 14* 6291 011 6600 1 **\$499.00**

*WEIGHT EXCLUDING BATTERY

*WEIGHT EXCLUDING BATTERY & CUTTING ATTACHMENT

BATTERY HIGH-PRESSURE CLEANERS



		OPERATING PRESSURE (BAR)	OPERATING PRESSURE (PSI)	MAX PRESSURE (BAR)	WEIGHT (KG)	ORDER NUMBER	MIN ORDER	RRP INC. GST
ASII SYSTEM RCA 20 KIT Supplied with 2x AS 2 batteries and AL 1 charger		22	320	24	1.3*	RA02 011 7615	1	\$329.00
	SKIN ONLY	22	320	24	1.3*	RA02 011 7600	1	\$249.00
ROTARY WASH BRUSH (Optional accessory suits RCA 20 only)						RA02 500 5900	1	\$60.00
AKIII SYSTEM REA 60 PLUS SKIN		100	1,450	130	7	RA01 011 7600	1	\$449.00
		125	1,800	150	7	RA01 011 7610	1	\$549.00
TROLLEY WITH 20L TANK (Optional accessory suits REA 60 PLUS and REA 100 PLUS only)						RA01 500 9800	1	\$159.00

 PLEASE SEE PAGE 80 FOR REA ACCESSORIES

BATTERY AIR INFLATOR



		WEIGHT (KG)	ORDER NUMBER	MIN ORDER	RRP INC. GST
KOA 20 KIT Supplied with AS 2 battery and AL 1 charger		1.7	SA06 011 8216	1	\$249.00
	SKIN ONLY	1.5*	SA06 011 8200	1	\$169.00

BATTERY VACUUM CLEANER









		WEIGHT (KG)	CONTAINER VOLUME (L)	ORDER NUMBER	MIN ORDER	RRP INC. GST
ASII SYSTEM SEA 20 KIT Supplied with AS 2 battery and AL 1 charger		1.1*	0.75	SA03 011 7314	1	\$279.00
	SKIN ONLY	1.1*	0.75	SA03 011 7300	1	\$199.00
AKIII SYSTEM NEW SEA 60 SKIN		7.5	12	SA04 011 7300	1	\$399.00
AKIII SYSTEM NEW SEA 100 SKIN		7.5	12	SA04 011 7310	1	\$599.00

*WEIGHT EXCLUDING BATTERY

BATTERY VACUUM CLEANER ACCESSORIES







	ORDER NUMBER	RRP INC. GST		ORDER NUMBER	RRP INC. GST
SEA 20 MINI NOZZLE KIT 	SA03 007 1000	\$25.00 MIN ORDER: 1	SEA 20 FILTER 	SA03 080 1900	\$10.00 MIN ORDER: 1
SEA 20 REPLACEMENT FLOOR TOOL 	SA03 500 2700	\$10.00 MIN ORDER: 1			

BATTERY LAWN MOWERS

	CUTTING HEIGHT	WEIGHT (KG)	ORDER NUMBER	MIN ORDER	RRP INC. GST
AKIII SYSTEM RMA 235 33CM SKIN 	25 - 60MM	14*	6311 011 1417	1	\$399.00
RMA 239 KIT 37CM Supplied with AL 101 and AK 30 	20 - 70MM	14*	6320 011 1465		\$679.00
	SKIN ONLY		6320 011 1432	1	\$499.00
NEW RMA 348 46CM SKIN 	25 - 100MM	25.8*	WA31 011 1410	1	\$599.00
NEW RMA 348 V 46CM SKIN 	25 - 100MM	28*	WA31 011 1430	1	\$699.00
APIII SYSTEM NEW RMA 353 51CM SKIN 	25 - 100MM	28.1*	WA32 011 1410	1	\$699.00
NEW RMA 353 V 51CM SKIN 	25 - 100MM	31.7*	WA32 011 1430	1	\$799.00
RMA 443 C 41CM SKIN (While stocks last) 	25 - 75MM	21*	6338 011 1415	1	\$549.00
	AMK 043 MULCH KIT		6909 007 1083	1	\$92.00
RMA 765 V 63CM SKIN Requires AR L battery or ADA 1000 to use AP batteries (Not included) 	25 - 100MM	44*	6392 011 1407	1	\$3,299.00
	AMK 065 MULCH KIT		6909 007 1063	1	\$56.00

*WEIGHT EXCLUDING BATTERY

NEXT GEN iMOW® ROBOTIC MOWERS - AVAILABLE TO QUALIFIED DEALERS ONLY

		MAXIMUM LAWN AREA (M ²)	WEIGHT (KG)	ORDER NUMBER	MIN ORDER	RRP INC. GST
iMOW® 5 ROBOTIC MOWER Includes docking station Excludes installation kit		1,500*	14.5	IA01 011 1405	1	\$2,899.00
iMOW® 5 EVO ROBOTIC MOWER Includes docking station Excludes installation kit		1,500*	15	IA01 011 1415	1	\$3,199.00
iMOW® 6 ROBOTIC MOWER Includes docking station Excludes installation kit		3,000*	15	IA01 011 1435	1	\$3,299.00
iMOW® 6 EVO ROBOTIC MOWER Includes docking station Excludes installation kit		3,000*	15	IA01 011 1445	1	\$3,599.00
iMOW® 7 ROBOTIC MOWER Includes docking station Excludes installation kit		5,000*	15.4	IA01 011 1465	1	\$3,699.00
iMOW® 7 EVO ROBOTIC MOWER Includes docking station Excludes installation kit		5,000*	15.4	IA01 011 1475	1	\$3,999.00

NEXT GEN iMOW® ACCESSORIES

	ORDER NUMBER	RRP INC. GST		ORDER NUMBER	RRP INC. GST
iMOW® SUN CANOPY	IA01 780 4300	\$379.00 MIN ORDER: 1	BASIC BLADES 18 PIECES	IA00 007 4202	\$65.00 MIN ORDER: 1
iMOW® BASE DOCKING STATION	IA01 430 9635	\$759.00 MIN ORDER: 1	iMOW® EVO DOCKING STATION	IA01 430 9625	\$759.00 MIN ORDER: 1
iMOW® INSTALL KIT	IA00 007 1004	\$249.00 MIN ORDER: 1	iMOW® FIXING NAIL 3.4 MM/ 75 PIECES	IA00 007 1000	\$39.00 MIN ORDER: 1
iMOW® PERIMETER WIRE 3.4/ 150	IA00 400 8600	\$169.00 MIN ORDER: 1	iMOW® BIO FIXING NAIL 3.4 MM/ 100 PIECES	IA00 007 1001	\$79.00 MIN ORDER: 1
iMOW® PERIMETER WIRE 3.4/ 500	IA00 400 8601	\$449.00 MIN ORDER: 1	iMOW® UPGRADE KIT 10	IA01 007 4700	\$99.00 MIN ORDER: 1
FIX KIT (Contains 5m wire, 10x fixing nails and 6x wire connectors)	IA00 007 1007	\$29.00 MIN ORDER: 1	iMOW® WIRE CONNECTOR 10 PIECES	IA00 007 1002	\$39.00 MIN ORDER: 1

*UP TO APPROXIMATELY
*NO LONGER AVAILABLE TO ORDER

*THIS WIRE IS DESIGNED TO BE USED WITH A CABLE-LAYING MACHINE, AND WILL NOT WORK EFFECTIVELY WITH WIRE STAKES.
IF STAKES MUST BE USED (EG. A SEARCH LOOP) THE OUTER COATING OF THE WIRE MUST BE REMOVED USING CABLE STRIPPERS.

iMOW® INSTALLATION KITS & MODEL OPTIONS

	ORDER NUMBER	RRP INC. GST		ORDER NUMBER	RRP INC. GST
SMALL INSTALL KIT 2.3MM, 150M WIRE, 150 PEGS	6909 007 1053	\$194.00 MIN ORDER: 1	AFN 075 FIXING PINS - 75 PACK	6301 007 1011	\$24.00 MIN ORDER: 1
LARGE INSTALL KIT 2.3MM, 400M WIRE - 375 PEGS	6909 007 1029	\$378.00 MIN ORDER: 1	WHEEL ASSEMBLY HEAVY FRONT AVS100.0	6909 007 1052	\$133.00 MIN ORDER: 1
ARB 501 MEDIUM PERIMETER WIRE 3.4MM (500M)	0000 400 8626	\$459.00 MIN ORDER: 1	AIP 602 iPROTECT (SHADE COVER)	6909 780 5401	\$337.00 MIN ORDER: 1
ADV 010 WIRE CONNECTORS - 10 PACK	6909 007 1091	\$24.00 MIN ORDER: 1	ARB 300+ HEAVY DUTY PERIMETER WIRE 5.5MM (300M) This wire is designed to be used with a cable laying machine and will not work effectively with wire stakes	0000 400 8615	\$641.00 MIN ORDER: 1
ARB 151.0 PERIMETER WIRE 2.3MM (150M)	0000 400 8631	\$148.00 MIN ORDER: 1			



RMI 422 P ACCESSORIES

	ORDER NUMBER	RRP INC. GST		ORDER NUMBER	RRP INC. GST
DOCKING STATION ADO 401	6909 430 9623	\$599.00 MIN ORDER: 1	SERVICE FLAP 4 SERIES	6301 706 2490	\$19.00 MIN ORDER: 1
CARRIER PLATE WITH BLADE NUT - BLADE EXCLUDED	6301 760 9701	\$65.00 MIN ORDER: 1	ART 220 HIGH TRACTION WHEELS SET - 4 SERIES	6909 700 0425	\$67.00 MIN ORDER: 1
BLADE 20CM	6301 702 0101	\$23.00 MIN ORDER: 1			

RMI 632 P ACCESSORIES





	ORDER NUMBER	RRP INC. GST		ORDER NUMBER	RRP INC. GST
DOCKING STATION ADO 601	6909 430 9628	\$699.00 MIN ORDER: 1	ALM 030 6 SERIES LONGER 30CM BLADE	6909 007 1022	\$56.00 MIN ORDER: 1
CARRIER PLATE WITH BLADE NUT - BLADE EXCLUDED	6909 760 9700	\$74.00 MIN ORDER: 1	ART 240 6 SERIES HIGH TRACTION WHEELS SET	6909 700 0412	\$77.00 MIN ORDER: 1
BLADE 28CM	6309 702 0102	\$32.00 MIN ORDER: 1			

iMOW® ACCESSORIES





	ORDER NUMBER	RRP INC. GST		ORDER NUMBER	RRP INC. GST
STAKE (DOCKING STATION)	6309 405 8710	\$11.00 MIN ORDER: 1	DC4 ELECTRICAL GREASE	0781 110 1011	\$49.00 MIN ORDER: 1
AKM 100 RESISTOR (REQUIRED FOR IN-STORE DISPLAY)	6909 007 1089	\$42.00 MIN ORDER: 1	GEAR LUBRICANT While stocks last	0781 120 1022	\$14.00 MIN ORDER: 1
MULTICLEAN (RMI/RMA) 500ML 	0782 516 8200	\$37.00 MIN ORDER: 1	CARE & CLEAN KIT 	0782 516 8600	\$56.00 MIN ORDER: 1

*UP TO APPROXIMATELY







AK / AP / AR BATTERY STORAGE ACCESSORIES

	ORDER NUMBER	RRP INC. GST		ORDER NUMBER	RRP INC. GST
SYSTAINER BATTERY STORAGE BOX AP SMALL 	0000 882 9703	\$92.00 MIN ORDER: 1	SYSTAINER BATTERY STORAGE BOX AP MEDIUM 25.5 L 	0000 882 9704	\$113.00 MIN ORDER: 1
SYSTAINER BATTERY STORAGE BOX AP LARGE 41.5 L 	0000 882 9705	\$123.00 MIN ORDER: 1	AP BATTERY CARRIER Holds 6 x AP batteries. Stackable max 3x high. 	4850 490 0600	\$40.00 MIN ORDER: 1
BATTERY STORAGE BOX ORGANISER INSERT Suits old Sortimo box. Spare tray to fit small boxes only	7013 871 0006	\$15.00 MIN ORDER: 1			

AS & AI BATTERY ACCESSORIES

	ORDER NUMBER	RRP INC. GST		ORDER NUMBER	RRP INC. GST
GTA 26 HOLSTER For use with the GTA 26 Battery Pruner 	GA01 490 1700	\$46.00 MIN ORDER: 1	AI SYSTEM REPLACEMENT SAFETY KEY For HSA 45, FSA 45 & BGA 45 	4511 405 7400	\$8.00 MIN ORDER: 1
GTA 40 HOLSTER For use with the GTA 40 Battery Pruner 	GA04 490 1700	\$99.00 MIN ORDER: 1	HSA 26 EXTENSION SHAFT 	HA03 710 7100	\$113.00 MIN ORDER: 1
GTA 26 EXTENSION SHAFT 	GA01 820 5000	\$165.00 MIN ORDER: 1			

AK BATTERY ACCESSORIES



	ORDER NUMBER	RRP INC. GST		ORDER NUMBER	RRP INC. GST
FOOT MOUNTING KIT KMA 80 R 	FA08 007 1001	\$61.00 MIN ORDER: 1	FLAT NOZZLE BGA 56 / BGA 57 / BGA 86 / BGA 100 	4866 701 8301	\$25.00 MIN ORDER: 1
HTA 50 EXTENSION SHAFT (50CM) 	LA02 820 5000	\$65.00 MIN ORDER: 1	AK DUMMY BATTERY 	4520 011 0590	\$16.00 MIN ORDER: 1
CARRY BAG KM & KMA 	0000 881 0507	\$82.00 MIN ORDER: 1	HLA 56 EXTENSION SHAFT (50CM) 	HA01 820 5000	\$77.00 MIN ORDER: 1

AP / AR BATTERY ACCESSORIES















	ORDER NUMBER	RRP INC. GST		ORDER NUMBER	RRP INC. GST
NEW STROP ADAPTER Suits MSA 161 T, NEW MSA 190 T, MSA 220 T / 220 TC-O	0000 490 2200	\$449.00 MIN ORDER: 1		NEW COMFORT HOOK Suits: NEW MSA 190 T	MA05 830 0400 \$79.00 MIN ORDER: 1
NEW GRID Suits: NEW MSA 190 T	MA05 084 1200	\$39.00 MIN ORDER: 1		NEW METAL BUMPER SPIKE Suits: NEW MSA 190 T	MA05 660 0800 \$19.00 MIN ORDER: 1
AP HOLSTER WITH CONNECTING CABLE Use on battery belt or in carrying system - backpack	4850 440 5101	\$240.00 MIN ORDER: 1		WEIGHT KIT Attaches to the AP adapter to improve the balance of the machine, e.g. for FSA 90 Approx 500g	4850 007 1001 \$34.00 MIN ORDER: 1
POUCH To fit battery belt for storing AP battery	4850 491 0101	\$39.00 MIN ORDER: 1		CATCHER PLATE HS 45 / HSA / HLA / HSE	4859 740 3300 \$50.00 MIN ORDER: 1
BATTERY BELT HARNESS	4850 490 0500	\$82.00 MIN ORDER: 1		CATCHER PLATE HSA 140 T HA02 740 3300 \$55.00 MIN ORDER: 1	
CARRYING SYSTEM BACKPACK AP For use with the AP holster with connecting cable	4850 490 0400	\$194.00 MIN ORDER: 1		CATCHER PLATE HSA 140 HSA 140 R HA02 740 3302 \$65.00 MIN ORDER: 1	
HIP PAD KIT FSA & BGA For use with AR backpacks & backpack carrying system	0000 007 1045	\$51.00 MIN ORDER: 1		FOOT MOUNTING KIT HLA 135 HTA 135 KMA 135 R	LA01 007 1002 \$61.00 MIN ORDER: 1
HARNESS BELT CONNECTOR Included in the hip pad kit	4866 007 1000	\$10.00		FOOT MOUNTING KIT HLA 56 HTA 50	HA01 007 1000 \$66.00 MIN ORDER: 1
BGA 200 HIP PAD KIT Including L hook	BA01 490 0400	\$148.00 MIN ORDER: 1		FOOT MOUNTING KIT HTA 65 / 66 HTA 85 / 86 HLA 85 / 86	4857 007 1001 \$56.00 MIN ORDER: 1
PLUG COVER FOR BATTERY POWERED TOOLS WITH LEAD CONNECTION	4850 432 2301	\$8.00 MIN ORDER: 1		FOOT MOUNTING KIT KMA 200 R	FA03 007 1001 \$61.00 MIN ORDER: 1
AP ADAPTER	4850 440 0505	\$87.00 MIN ORDER: 1		CONNECTING CORD & ADAPTER AR to AP connecting cord. Not suitable for AR L batteries	7004 200 0011 \$190.00 MIN ORDER: 1
BLANK COVER AP	4850 602 0900	\$10.00 MIN ORDER: 1		BGA 250 HARNESS	BA06 710 9000 \$75.00 MIN ORDER: 1

ONLY FIRST BATTERY SLOT IS FUNCTIONAL WHEN USED WITH BGA 3000



AR L BATTERY ACCESSORIES

	ORDER NUMBER	RRP INC. GST		ORDER NUMBER	RRP INC. GST
AR L CARRY SYSTEM Excludes connecting cord. Not included with AR 2000 L & AR 3000 L sets	4871 490 0400	\$230.00 MIN ORDER: 1		ADA 1000 DOUBLE AP BATTERY ADAPTER For use of 2 AP batteries with BGA 300.0#, BGA 300.1 & RMA 765 V. Batteries sold separately. AP 300 S & AP 500 S recommended	6909 400 4300 \$419.00 MIN ORDER: 1
CONNECTING CABLE FOR AR L BATTERIES Included in AR 2000 L & AR 3000 L sets	4871 440 2000	\$205.00 MIN ORDER: 1			

BATTERIES

			VOLTS	AMP HRS	WATT HRS	WEIGHT KG	ORDER NUMBER	RRP INC. GST
AS 2			10.8	2.6	28	0.22	EA02 400 6500	\$89.00 MIN ORDER: 1
AK 10			36	1.4	72	0.8	4520 400 6515	\$169.00 MIN ORDER: 1
AK 20			36	2.8	144	1.2	4520 400 6535	\$219.00 MIN ORDER: 1
AK 30 S			36	5.0	180	1.3	4520 400 6545	\$319.00 MIN ORDER: 1
AP 200 S			36	5.2	187	1.3	4850 400 6565	\$309.00 MIN ORDER: 1
NEW AP 300 S (2.5 kW Version)			36	7.2	281	1.8	4850 400 6575	\$379.00 MIN ORDER: 1
NEW AP 500 S (3.5 kW Version)			36	9.6	337	2	EA01 400 6505	\$599.00 MIN ORDER: 1
AR 2000 BACKPACK Includes lead, AP adapter & carry system			36	21.8	916	7.4	4865 400 6511	\$999.00 MIN ORDER: 1
AR 2000 L Excludes lead, AP adapter & carry system			36	27.4	1,015	7.4	4871 400 6515	\$1,999.00 MIN ORDER: 1
			AR 2000 L SET WITH CORD & AP ADAPTER		4871 200 0008	\$2,199.00 MIN ORDER: 1		
			AR 2000 L SET WITH CORD, AP ADAPTER & CARRY SYSTEM		4871 200 0012	\$2,399.00 MIN ORDER: 1		
AR 3000 L Excludes lead, AP adapter & carry system			36	41.2	1,522	9.5	4871 400 6525	\$2,549.00 MIN ORDER: 1
			AR 3000 L SET WITH CORD & AP ADAPTER		4871 200 0009	\$2,749.00 MIN ORDER: 1		
			AR 3000 L SET WITH CORD, AP ADAPTER & CARRY SYSTEM		4871 200 0013	\$2,949.00 MIN ORDER: 1		

CHARGERS

	ORDER NUMBER	RRP INC. GST		ORDER NUMBER	RRP INC. GST
AL 5 QUICK	EA03 430 5705	\$99.00 MIN ORDER: 1		AL 5-2 QUICK	EA11 430 5705 \$159.00 MIN ORDER: 1
AL 101	4850 430 2525	\$99.00 MIN ORDER: 1		AL 301 QUICK	EA09 430 5505 \$199.00 MIN ORDER: 1
AL 500 SUPER QUICK	4850 430 5705	\$279.00 MIN ORDER: 1		AL 301-4 4 PORT QUICK CHARGER	EA04 430 5505 \$499.00 MIN ORDER: 1
				Suitable for AP batteries only	

ONLY FIRST BATTERY SLOT IS FUNCTIONAL WHEN USED WITH BGA 300.0

BATTERY RUN TIMES

AS 2



AK 10



AK 20



AK 30 S



BATTERY CHARGING TIMES (MIN) ①

AL 1	-	-	-	-
AL 1	55/70	-	-	-
AL 5	30/50	-	-	-
AL 5-2	30/50	-	-	-
AL 101	-	55/80	105/150	160/205
AL 301	-	20/30	25/45	35/60
AL 500	-	20/30	25/45	35/60



WORKING TIMES PER BATTERY CHARGE (UP TO ... MIN) ②

ASA 20	UP TO 2000 CUTS ②	-	-	-
BGA 30	7	-	-	-
FSA 30	19	-	-	-
GTA 26	25	-	-	-
GTA 40	50 (2x AS 2)	-	-	-
NEW HLA 40	40	-	-	-
HSA 26	110	-	-	-
HSA 30	50	-	-	-
HSA 40	40	-	-	-
NEW HTA 30	28 (2x AS 2)	-	-	-
KOA 20	UP TO 23	-	-	-
PS 1	80	-	-	-
RCA 20	7.5 - 15	-	-	-
SEA 20	14	-	-	-



WORKING TIMES PER BATTERY CHARGE (UP TO ... MIN) ②

BGA 50	-	9	18	23
BGA 60	-	10	22	27
NEW FSA 50 with nylon mowing head	-	25	50	60
FSA 57 with nylon mowing head	-	25	50	60
FSA 70 R	-	30 - 15 ^③	45 - 25 ^③	55 - 30 ^③
FSA 80 R	-	12 - 8 ^③	25 - 15 ^③	30 - 20 ^③
HLA 56	-	50	100	120
HSA 50	-	50	100	130
HSA 60	-	70	140	175
HTA 50	-	25	45	60
KMA 80 R with FS-GSB KM attachment	-	20 - 10+ ^③	40 - 20 ^③	50 - 30 ^③
MSA 60 C-B	-	18	40	55
MSA 70 C-B	-	18	40	45
MSA 80 C-B	-	-	-	35
REA 60 PLUS	-	12	20	25
NEW SEA 60	-	8 - 2 ^③	16 - 23 ^③	30 - 20 ^③
SHA 56	-	12	25	30

BATTERY RANGES (UP TO ... M²) ②

RMA 235	-	100	200	300
RMA 239	-	150	270	330
NEW RMA 348	-	-	-	265
NEW RMA 348 V	-	-	-	220
RLA 240	-	96	190	250

■ RECOMMENDED BATTERY
■ REDUCED TOOL PERFORMANCE

① CHARGING TIMES IN MINUTES UP TO 80% CAPACITY/100% CAPACITY

② THE WORKING TIMES PER BATTERY CHARGE & AREA SPECIFICATIONS ARE ESTIMATES & ③ LEVEL 1 - 2 MAY VARY DEPENDING ON HOW THE TOOL IS BEING USED & WHAT IS BEING CUT



AP 200 S



NEW AP 300 S



NEW AP 500 S



AR 2000



AR 2000 L



AR 3000 L



BATTERY CHARGING TIMES (MIN) ①

AL 101	125/ 165	230/ 300	280/ 355	-	-	-
AL 301	30/ 55	55/ 70	70/ 90	190/ 215	210/ 270	310/ 400
AL 301-4	40/ 55	55/ 80	70/ 90	210/ 270	220/ 290	330/ 430
AL 500	25/ 35	30/ 45	40/ 55	100/ 130	110/ 150	170/ 220

WORKING TIMES PER BATTERY CHARGE (UP TO ... MIN) ②

BGA 86	17	26	31	84	-	-
BGA 100	66, 28, 17, 12 ^③	103, 44, 26, 20 ^③	123, 52, 31, 24 ^③	300 - 60 ^③	375, 160, 100, 75 ^③	555, 225, 140, 105 ^③
BGA 160	75 - 10	110 - 15	130 - 17	-	415 - 53	625 - 80
BGA 200	49, 21, 11, 7 ^③	95, 38, 20, 14 ^③	114, 45, 24, 17 ^③	295 - 43 ^③	315, 146, 76, 53 ^③	500, 220, 117, 85 ^③
BGA 250	27, 17, 13, 13 ^③	40, 25, 17, 12 ^③	48, 30, 21, 14 ^③	-	145, 91, 62, 44 ^③	218, 136, 93, 65 ^③
BGA 300	16, 13, 13, 13 ^③	25, 18, 14, 10 ^③	29, 21, 17, 12 ^③	-	97, 72, 57, 48 ^③	140, 105, 83, 61 ^③
NEW BRA 600	18 ^{④⑤}	29 ^{④⑤}	34 ^{④⑤}	-	-	-
FSA 110 R with nylon mowing head	60 - 30	100 - 50	120 - 60	-	380 - 190	540 - 270
FSA 120 R with nylon mowing head	-	50 - 30	60 - 35	-	200 - 120	300 - 170
FSA 120 with grass-cutting blade	-	100 - 60	130 - 70	-	380 - 200	510 - 280
FSA 135 R with nylon mowing head	28 - 17 ^④	45 - 25 ^{④⑤}	54 - 30 ^④	180 ^④	160 - 90 ^④	200 - 130 ^④
FSA 135 with grass-cutting blade	50 - 30 ^④	100 - 50 ^{④⑤}	54 - 30 ^④	150/82 ^④	310 - 160 ^{④⑥}	430 - 240 ^④
FSA 200 R with nylon mowing head	-	32 - 16	40 - 20	-	120 - 60	180 - 90
FSA 200 with grass-cutting blade	-	60 - 30	70 - 35	-	210 - 105	315 - 150
FSA 400 with nylon mowing head	-	20 - 12	25 - 15	-	-	-
HLA 66	144	223	268	660	730	1000
HLA 86	144	223	268	660	730	1000
HLA 135 K	64	95	114	310	345	520
HLA 135	64	95	114	310	345	520
HSA 100	150	225	270	-	1,135	1,700
HSA 130 T	108 - 84 ^③	167 - 130 ^③	200 - 155 ^③	-	690 - 565 ^③	985 - 800 ^③
HSA 130 R	108 - 84 ^③	167 - 130 ^③	200 - 155 ^③	-	690 - 565 ^③	985 - 800 ^③
HSA 140 R	150 - 110	245 - 175	290 - 210	-	880 - 630	1320 - 945
HSA 140 T	140 - 90	235 - 150	280 - 180	-	850 - 545	1270 - 815
HTA 86	42	68	82	180	190	300
HTA 135	22	45	54	130	160	240
HTA 160	22	45	54	130	160	240
KGA 770	168	260	312	-	-	-
MSA 160 C-B	42	62	74	180	190	300
MSA 161 T	42	62	74	180	190	300
NEW MSA 190 T	48	75	90	-	-	-
MSA 200 C-B	42	56	60	160	175	260
MSA 220 C-B	32	37	44	160	201	281
MSA 220 T	16	29	34	-	109	174
MSA 220 TC-O	16	29	34	-	109	174
MSA 300 C-O	-	-	44	-	-	-
REA 100 PLUS	-	45	-	-	-	-
NEW SEA 100	29 - 17 ^⑦	44 - 26 ^⑦	53 - 32 ^⑦	-	-	-
SHA 140	39 - 25	60 - 38	71 - 44	-	-	-
SGA 85	510	-	-	-	-	-
TSA 230	14	22	26	75	82	120
TSA 300	9	16	22	-	-	-

■ RECOMMENDED BATTERY
 ■ REDUCED TOOL PERFORMANCE
 ① CHARGING TIMES IN MINUTES UP TO 80% CAPACITY/100% CAPACITY

② THE WORKING TIMES PER BATTERY CHARGE & AREA SPECIFICATIONS ARE ESTIMATES & MAY VARY DEPENDING ON HOW THE TOOL IS BEING USED & WHAT IS BEING CUT
 ③ LEVEL 1 - 3/4

④ RECOMMENDED BATTERY FOR FSA 135 R
 ⑤ RECOMMENDED BATTERY FOR FSA 135
 ⑥ LEVEL 1 - LEVEL 3/BOOST
 ⑦ LEVEL 1 - 2

⑧ LEVEL 1
 ⑨ REFERS TO TWO AP BATTERIES



KMA 135 R TOOL WORKING TIMES PER BATTERY CHARGE (MIN) ②

KMA 135 R + BRUSHCUTTER FS-KM - nylon mowing head ^③	28 - 14 ^③	45 - 22 ^②	54 - 26 ^③	150 - 70 ^③	160 - 80 ^③	200 - 115 ^③
KMA 135 R + BRUSHCUTTER FS-KM - grass cutting blade ^③	50 - 30 ^③	100 - 50 ^③	120 - 60 ^③	300 - 150 ^③	310 - 160 ^③	430 - 240 ^③
HEDGE TRIMMER 145° HL-KM	123 - 81 ^③	229 - 152 ^③	275 - 182 ^③	733 - 486 ^③	810 - 540 ^③	1150 - 790 ^③
SCRUB CUTTER 145° FH-KM	123 - 81 ^③	229 - 152 ^③	275 - 182 ^③	733 - 486 ^③	810 - 540 ^③	1150 - 790 ^③
BLOWER BG-KM	26 - 10 ^③	48 - 19 ^③	58 - 29 ^③	153 - 57 ^③	170 - 60 ^③	245 - 90 ^③
POLE PRUNER HT-KM	42 - 19 ^③	78 - 36 ^③	97 - 43 ^③	250 - 112 ^③	275 - 120 ^③	320 - 180 ^③
SWEEPER RUBBER PADDLES KW-KM	31 - 25 ^③	57 - 46 ^③	68 - 55 ^③	183 - 145 ^③	200 - 160 ^③	300 - 230 ^③
BRISTLE BRUSH KB-KM	31 - 25 ^③	57 - 46 ^③	68 - 55 ^③	183 - 145 ^③	200 - 160 ^③	300 - 230 ^③
PICK TYNES BF-KM	31 - 25 ^③	57 - 46 ^③	68 - 55 ^③	183 - 145 ^③	200 - 160 ^③	300 - 230 ^③
EDGER BENT SHAFT FCB-KM	23 - 12 ^③	41 - 22 ^③	49 - 26 ^③	131 - 69 ^③	145 - 75 ^③	210 - 110 ^③
EDGER STRAIGHT SHAFT FCS-KM	23 - 12 ^③	41 - 22 ^③	49 - 26 ^③	131 - 69 ^③	145 - 75 ^③	210 - 110 ^③
ROTARY TRIMMER RG-KM	57 ^④	85 ^④	102 ^④	280 ^④	300 ^④	450 ^④
HARVESTER SP-KM	51 - 33 ^③	97 - 62 ^③	116 - 74 ^③	383 - 246 ^③	330 - 215 ^③	490 - 320 ^③
BED REDEFINER FBD-KM	9 - 9 ^③	14 - 14 ^③	17 - 17 ^③	55-55 ^③	60 - 60 ^③	90 - 90 ^③







BATTERY RANGES (UP TO ... M²) ②

NEW RMA 353	-	335	421	-	-	-
NEW RMA 353 V	-	286	343	-	-	-
RMA 443 C	300	560	650	-	-	-
RMA 765 V	-	400	480	-	2,050	3,100

ELECTRIC CHAINSAWS

		POWER OUTPUT WATTS (W)	WEIGHT (KG)	ORDER NUMBER	MIN ORDER	RRP INC. GST
MSE 141 C 30CM/12" 		1400	4.1	1208 200 0342	1	\$199.00
	REPLACEMENT CHAIN LOOP 61 PMM3 3/8" .043" - 44DL 30CM/12"			3610 000 0044	1	\$34.00
	REPLACEMENT GUIDE BAR 3/8" .043" 30CM/12" ROLLOMATIC MINI			3005 008 3905	1	\$62.00
MSE 170 C-B 35CM/14" 		1700	4.4	1209 200 0050	1	\$459.00
	REPLACEMENT CHAIN LOOP PMM3 - 3/8" .043" - 51DL - 35CM/14"			3610 000 0051	1	\$39.00
	REPLACEMENT GUIDE BAR 3/8" .043" - 35CM/14" ROLLOMATIC MINI			3005 803 3909	1	\$72.00

PETROL CHAINSAWS FOR CUTTING FIREWOOD & PROPERTY MAINTENANCE

		DISPLACEMENT (CM ³)	POWER OUTPUT (KW/HP)	WEIGHT (KG)	ORDER NUMBER	MIN ORDER	RRP INC. GST
MS 162 30CM/12" 		30.1	1.2/1.6	4.5KG	1148 200 0260	1	\$349.00
	REPLACEMENT CHAIN LOOP PMM3 - 3/8"P .043 - 44DL - 30CM/12"				3610 000 0044	1	\$34.00
	COMPATIBLE GUIDE BAR* 3/8" .043" - 30CM/12" - LIGHT 01				3005 008 3905	1	\$62.00
MS 172 35CM/14" 		31.8	1.4/1.9	4.5KG	1148 200 0267	1	\$399.00
	REPLACEMENT CHAIN LOOP PMM3 - 3/8"P .043" - 50DL - 35CM/14"				3610 000 0050	1	\$39.00
	REPLACEMENT GUIDE BAR 3/8" .043" - 35CM/14" - ROLLOMATIC MINI				3005 803 3909	1	\$72.00
MS 172 C-BE 35CM/14" 		31.8	1.4/1.9	4.8KG	1148 200 0268	1	\$499.00
	REPLACEMENT CHAIN LOOP PMM3 - 3/8"P .043" - 50DL - 35CM/14"				3610 000 0050	1	\$39.00
	REPLACEMENT GUIDE BAR 3/8" .043" - 35CM/14" - ROLLOMATIC MINI				3005 803 3909	1	\$72.00
MS 182 40CM/16" 		35.8	1.6/2.1	4.6KG	1148 200 0265	1	\$499.00
	REPLACEMENT CHAIN LOOP 63 PM3 PICCO MICRO CHAIN				3636 000 0055	1	\$40.00
	REPLACEMENT GUIDE BAR 3/8" .050" - 40CM/16" - LIGHT 04				3005 000 4813	1	\$87.00
MS 182 C-BE 40CM/16" 		35.8	1.6/2.1	4.9KG	1148 200 0262	1	\$599.00
	REPLACEMENT CHAIN LOOP 63 PM3 PICCO MICRO CHAIN				3636 000 0055	1	\$40.00
	REPLACEMENT GUIDE BAR 3/8" .050" - 40CM/16" - LIGHT 04				3005 000 4813	1	\$87.00
MS 211 40CM/16" While stocks last. 		35.2	1.7/2.3	4.3*	1139 200 0387	1	\$649.00
	REPLACEMENT CHAIN LOOP PM - 3/8"P .050" - 55DL - 40CM/16"				3613 000 0055	1	\$42.00
	REPLACEMENT GUIDE BAR 3/8" .050" - 40CM/16" - LIGHT 04				3005 000 4813	1	\$87.00

*WEIGHT EXCLUDING FUEL, GUIDE BAR & SAW CHAIN





*ORIGINAL OEM GUIDE BAR NOT AVAILABLE TO PURCHASE SEPARATELY

PETROL CHAINSAWS FOR CUTTING FIREWOOD & PROPERTY MAINTENANCE

	DISPLACEMENT (CM ³)	POWER OUTPUT (KW/HP)	WEIGHT (KG)	ORDER NUMBER	MIN ORDER	RRP INC. GST
MS 212 40CM/16" 	38.6	1.8/2.4	4.6 [^]	1148 200 0266	1	\$649.00
	REPLACEMENT CHAIN LOOP 63 PM3 PICCO MICRO CHAIN			3636 000 0055	1	\$40.00
	REPLACEMENT GUIDE BAR 3/8" .050" - 40CM/16" - LIGHT 04			3005 000 4813	1	\$87.00
MS 212 C-BE 40CM/16" 	38.6	1.8/2.4	4.9 [^]	1148 200 0263	1	\$749.00
	REPLACEMENT CHAIN LOOP 63 PM3 PICCO MICRO CHAIN			3636 000 0055	1	\$40.00
	REPLACEMENT GUIDE BAR 3/8" .050" - 40CM/16" - LIGHT 04			3005 000 4813	1	\$87.00
MS 231 40CM/16" 	42.6	2.0/2.7	4.8 [^]	1143 200 0727	1	\$799.00
	REPLACEMENT CHAIN LOOP RM .325" .050" PRO 62DL - 40CM/16"			3693 000 0062	1	\$44.00
	REPLACEMENT GUIDE BAR .325" .050" 40CM/16" LIGHT 04			3005 000 7013	1	\$87.00
MS 251 45CM/18" 	45.6	2.2/3.0	4.8 [^]	1143 200 0737	1	\$899.00
	REPLACEMENT CHAIN LOOP RM .325" .050" PRO 68DL - 45CM/18"			3693 000 0068	1	\$49.00
	REPLACEMENT GUIDE BAR .325" .050" 45CM/18" LIGHT 04			3005 008 7017	1	\$92.00
MS 251 C-BE 45CM/18" 	45.6	2.2/3.0	5.1 [^]	1143 200 0738	1	\$999.00
	REPLACEMENT CHAIN LOOP RM .325" .050" PRO 68DL - 45CM/18"			3693 000 0068	1	\$49.00
	REPLACEMENT GUIDE BAR .325" .050" 45CM/18" LIGHT 04			3005 008 7017	1	\$92.00









[^]WEIGHT EXCLUDING FUEL, GUIDE BAR & SAW CHAIN

PETROL CHAINSAWS FOR AGRICULTURE & HORTICULTURE

	DISPLACEMENT (CM ³)	POWER OUTPUT (KW/HP)	WEIGHT (KG)	ORDER NUMBER	MIN ORDER	RRP INC. GST
MS 271 45CM/18" 	50.2	2.6/3.5	5.6 [^]	1141 200 0764	1	\$999.00
	REPLACEMENT CHAIN LOOP					
	RM .325" .050" PRO 74DL - 45CM/18"			3693 000 0074	1	\$50.00
REPLACEMENT GUIDE BAR						
.325" .050" 45CM/18" LIGHT 04			3003 008 3317	1	\$100.00	
MS 291 45CM/18" 	55.5	2.8/3.8	5.6 [^]	1141 200 0752	1	\$1,199.00
	REPLACEMENT CHAIN LOOP					
	RM .325" .050" PRO 74DL - 45CM/18"			3693 000 0074	1	\$50.00
REPLACEMENT GUIDE BAR						
.325" .050" 45CM/18" LIGHT 04			3003 008 3317	1	\$100.00	
MS 311 50CM/20" FARMBOSS 	59	3.1/4.2	6.2 [^]	1140 200 0695	1	\$1,449.00
	REPLACEMENT CHAIN LOOP					
	RM - 3/8" .063" - 72DL - 50CM/20"			3652 000 0072	1	\$56.00
REPLACEMENT GUIDE BAR						
3/8" .063" - 50CM/20" LIGHT 04 FARMBOSS			3003 813 5221	1	\$103.00	
MS 391 50CM/20" FARMBOSS 	64.1	3.3/4.5	6.2 [^]	1140 200 0689	1	\$1,549.00
	REPLACEMENT CHAIN LOOP					
	RM - 3/8" .063" - 72DL - 50CM/20"			3652 000 0072	1	\$56.00
REPLACEMENT GUIDE BAR						
3/8" .063" - 50CM/20" LIGHT 04 FARMBOSS			3003 813 5221	1	\$103.00	

[^]WEIGHT EXCLUDING FUEL, GUIDE BAR & SAW CHAIN

PETROL CHAINSAWS FOR FORESTRY WORK

	DISPLACEMENT (CM ³)	POWER OUTPUT (KW/HP)	WEIGHT (KG)	ORDER NUMBER	MIN ORDER	RRP INC. GST
MS 261 C-M 40CM/16" 	50.2	3.0/4.1	4.9 [^]	1141 200 0749	1	\$1,649.00
	REPLACEMENT CHAIN LOOP			3690 000 0067	1	\$48.00
	RS - .325" .050" - 67DL - 40CM/16"					
REPLACEMENT GUIDE BAR			3003 000 3313	1	\$90.00	
.325" .050" 40CM/16" LIGHT 04						
MS 362 C-M 45CM/18" 	59	3.5/4.8	5.6 [^]	1140 200 0691	1	\$1,789.00
	REPLACEMENT CHAIN LOOP			3621 000 0066	1	\$50.00
	RS - 3/8" .063" - 66DL - 45CM/18" - CHISEL					
REPLACEMENT GUIDE BAR			3003 000 5217	1	\$103.00	
3/8" .063" - 45CM/18" - LIGHT 06						
MS 362 C-M 50CM/20" 	59	3.5/4.8	5.8 [^]	1140 200 0692	1	\$1,799.00
	REPLACEMENT CHAIN LOOP			3621 000 0072	1	\$56.00
	RS - 3/8" .063" - 72DL - 50CM/20" - CHISEL					
REPLACEMENT GUIDE BAR			3003 000 2021	1	\$230.00	
3/8" .063" - 50CM/20" - LIGHT 06						
MS 400 C-M 50CM/20" ES LIGHT 	66.8	4.0/5.3	5.8 [^]	1140 200 0475	1	\$1,999.00
	REPLACEMENT CHAIN LOOP			3621 000 0072	1	\$56.00
	RS - 3/8" .063" - 72DL - 50CM/20" - CHISEL					
REPLACEMENT GUIDE BAR			3003 000 2021	1	\$230.00	
3/8" .063" - 50CM/20" - ROLLOMATIC ES LIGHT						
 HEXA MS 400 C-M 50CM/20" ES LIGHT 	66.8	4.0/5.3	5.8 [^]	1140 200 0786	1	\$1,999.00
	REPLACEMENT CHAIN LOOP			3132 000 0072	1	\$55.00
	3/8" 36 RH RAPID - 72DL - 50CM/20" - HEXA					
REPLACEMENT GUIDE BAR			3003 000 2021	1	\$230.00	
3/8" .063" - 50CM/20" - ROLLOMATIC ES LIGHT						
MS 462 C-M 50CM/20" 	72.2	4.4/6.0	6.0 [^]	1142 200 0008	1	\$2,099.00
	REPLACEMENT CHAIN LOOP			3621 000 0072	1	\$56.00
	RS - 3/8" .063" - 72DL - 50CM/20" - CHISEL					
REPLACEMENT GUIDE BAR			3003 000 5221	1	\$113.00	
3/8" .063" - 50CM/20" - ROLLOMATIC						
MS 462 C-M 50CM/20" ES LIGHT 	72.2	4.4/6.0	6.0 [^]	1142 200 0114	1	\$2,159.00
	REPLACEMENT CHAIN LOOP			3621 000 0072	1	\$56.00
	RS - 3/8" .063" - 72DL - 50CM/20" - CHISEL					
REPLACEMENT GUIDE BAR			3003 000 2021	1	\$230.00	
3/8" .063" - 50CM/20" - ROLLOMATIC ES LIGHT						
 HEXA MS 462 C-M 50CM/20" ES LIGHT 	72.2	4.4/6.0	6.0 [^]	1142 200 0264	1	\$2,159.00
	REPLACEMENT CHAIN LOOP			3132 000 0072	1	\$55.00
	RTSN - 3/8" 36 RH RAPID - 72DL - 50CM/20" - HEXA					
REPLACEMENT GUIDE BAR			3003 000 2021	1	\$230.00	
3/8" .063" - 50CM/20" - ROLLOMATIC ES LIGHT						





*WEIGHT EXCLUDING FUEL, GUIDE BAR & SAW CHAIN

PETROL CHAINSAWS FOR FORESTRY WORK

		DISPLACEMENT (CM³)	POWER OUTPUT (KW/HP)	WEIGHT (KG)	ORDER NUMBER	MIN ORDER	RRP INC. GST
MS 500i LIGHT 50CM/20" LIGHT BAR 		79.2	5.0/6.8	6.4 [^]	1147 200 0021	1	\$2,449.00
	REPLACEMENT CHAIN LOOP RS - 3/8".063" - 72DL - 50CM/20" - CHISEL				3621 000 0072	1	\$56.00
	REPLACEMENT GUIDE BAR 3/8".063" - 50CM/20" ROLLOMATIC ES LIGHT				3003 000 2021	1	\$230.00
MS 500i LIGHT 63CM/25" LIGHT BAR 		79.2	5.0/6.8	6.4 [^]	1147 200 0023	1	\$2,469.00
	REPLACEMENT CHAIN LOOP RS - 3/8".063" - 84DL - 63CM/25" - CHISEL				3621 000 0084	1	\$61.00
	REPLACEMENT GUIDE BAR 3/8".063" - 63CM/25" ROLLOMATIC ES LIGHT				3003 000 2031	1	\$250.00
MS 500i LIGHT 50CM/20" LIGHT BAR 		79.2	5.0/6.8	6.4 [^]	1147 200 0093	1	\$2,469.00
	REPLACEMENT CHAIN LOOP RH - 3/8" 36 RH RAPID - 72DL - 50CM/20" - HEXA				3132 000 0072	1	\$55.00
	REPLACEMENT GUIDE BAR 3/8".063" - 50CM/20" ROLLOMATIC ES LIGHT				3003 000 2021	1	\$230.00
MS 661 C-M 63CM/25" MAGNUM 		91.1	5.4/7.3	7.4 [^]	1144 200 0332	1	\$2,499.00
	REPLACEMENT CHAIN LOOP RS - 3/8".063" - 84DL - 63CM/25" - CHISEL				3621 000 0084	1	\$61.00
	REPLACEMENT GUIDE BAR 3/8".063" - 63CM/25" - LIGHT O6				3003 000 5231	1	\$128.00
MS 661 C-M 63CM/25" ES LIGHT MAGNUM 		91.1	5.4/7.3	7.4 [^]	1144 200 0334	1	\$2,539.00
	REPLACEMENT CHAIN LOOP RS - 3/8".063" - 84DL - 63CM/25" - CHISEL				3621 000 0084	1	\$61.00
	REPLACEMENT GUIDE BAR 3/8".063" - 63CM/25" - ROLLOMATIC ES LIGHT				3003 000 2031	1	\$250.00
MS 661 C-M 63CM/25" MAGNUM .404 		91.1	5.4/7.3	7.4 [^]	1144 200 0348	1	\$2,549.00
	REPLACEMENT CHAIN LOOP RS - .404 .063" - 77DL - 63CM/25" - CHISEL				3946 000 0077	1	\$67.00
	REPLACEMENT GUIDE BAR .404 .063" - 63CM/25" - ROLLOMATIC ES				3003 000 9731	1	\$220.00
MS 881 63CM/25" MAGNUM Standard option shown 		121.6	6.4/8.7	9.9 [^]	1124 200 0225	1	\$3,299.00
	REPLACEMENT CHAIN LOOP RS - .404 .063" - 80DL - 63CM/25"				3946 000 0080	1	\$67.00
	REPLACEMENT GUIDE BAR .404 .063" - 63CM/25" - ROLLOMATIC ES				3002 000 9731	1	\$230.00
MS 881 75CM/30" MAGNUM 		121.6	6.4/8.7	9.9 [^]	1124 200 0226	1	\$3,320.00
	REPLACEMENT CHAIN LOOP RS - .404 .063" - 92DL - 75CM/30"				3946 000 0091	1	\$72.00
	REPLACEMENT GUIDE BAR .404 .063" - 75CM/30" - DUROMATIC E				3002 000 8041	1	\$194.00
MS 881 80CM/32" MAGNUM 		121.6	6.4/8.7	9.9 [^]	1124 200 0228	1	\$3,340.00
	REPLACEMENT CHAIN LOOP RM - .404 .063" - 100DL - 80CM/32"				3668 000 0100	1	\$77.00
	REPLACEMENT GUIDE BAR .404 .063" - 80CM/32" - DUROMATIC E				3002 000 8045	1	\$220.00
MS 881 90CM/36" MAGNUM 		121.6	6.4/8.7	9.9 [^]	1124 200 0227	1	\$3,360.00
	REPLACEMENT CHAIN LOOP RS - .404 .063" - 104DL - 90CM/36"				3946 000 0104	1	\$77.00
	REPLACEMENT GUIDE BAR .404 .063" - 90CM/36" - DUROMATIC E				3002 000 8052	1	\$240.00

[^]WEIGHT EXCLUDING FUEL, GUIDE BAR & SAW CHAIN



PETROL CHAINSAWS FOR ARBORIST WORK

	DISPLACEMENT (CM ³)	POWER OUTPUT (KW/HP)	WEIGHT (KG)	ORDER NUMBER	MIN ORDER	RRP INC. GST
MS 151 T-CE 30CM/12" 	23.6	1.1/1.5	2.6 [^]	1146 200 0064	1	\$799.00
	REPLACEMENT CHAIN LOOP			3670 000 0064	1	\$46.00
	PM3 - 1/4" .043" - 64DL - 30CM/12"					
MS 194 T 30CM/12" 	31.8	1.4/1.9	3.3 [^]	1137 200 0418	1	\$899.00
	REPLACEMENT CHAIN LOOP			3699 000 0044	1	\$36.00
	PS3 - 3/8"P - .043" -44DL - 30CM/12"					
MS 201 TC-M 30CM/12" 	35.2	1.8/2.4	3.7 [^]	1145 200 0335	1	\$1,549.00
	REPLACEMENT CHAIN LOOP			3699 000 0044	1	\$36.00
	PS3 - 3/8"P - .043" -44DL - 30CM/12"					
MS 201 TC-M 35CM/14" 	35.2	1.8/2.4	3.7 [^]	1145 200 0334	1	\$1,559.00
	REPLACEMENT CHAIN LOOP			3699 000 0050	1	\$36.00
	PS3 - 3/8"P - .043" -50DL - 35CM/14"					
	REPLACEMENT GUIDE BAR			3005 000 4405	1	\$70.00
	1/4" .043" - 30CM/12" - ROLLOMATIC MINI					
	3/8" .043" - 30CM/12" - LIGHT 04					
REPLACEMENT GUIDE BAR			3005 000 4405	1	\$70.00	
3/8" .043" - 30CM/12" - LIGHT 04						
REPLACEMENT GUIDE BAR			3005 000 4405	1	\$70.00	
3/8" .043" - 30CM/12" - LIGHT 04						
REPLACEMENT GUIDE BAR			3005 000 4405	1	\$70.00	
3/8" .043" - 30CM/12" - LIGHT 04						
REPLACEMENT GUIDE BAR			3005 000 4405	1	\$70.00	
3/8" .043" - 30CM/12" - LIGHT 04						
REPLACEMENT GUIDE BAR			3005 000 4405	1	\$70.00	
3/8" .043" - 30CM/12" - LIGHT 04						
REPLACEMENT GUIDE BAR			3005 000 4405	1	\$70.00	
3/8" .043" - 30CM/12" - LIGHT 04						

PETROL CHAINSAW FOR EMERGENCY SERVICE

	DISPLACEMENT (CM ³)	POWER OUTPUT (KW/HP)	WEIGHT (KG)	ORDER NUMBER	MIN ORDER	RRP INC. GST
MS 462 C-M R 50CM/20" Depth limiter not included (sold separately) 	72.2	4.4/6.0	7.2 [^]	1142 200 0133	1	\$2,599.00
	REPLACEMENT CHAIN LOOP			3944 000 0072	1	\$398.00
	RDR - 3/8" .063" - 72DL - 50CM/20" - DURO					
	REPLACEMENT GUIDE BAR			3003 002 9421	1	\$169.00
3/8" .063" - 50CM/20" - ROLLOMATIC						
DEPTH LIMITER FOR MS 462 C-M R			3003 650 6503	1	\$361.00	

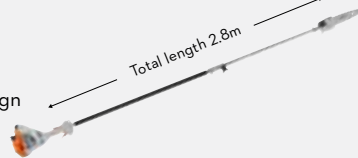
PETROL POLE PRUNERS

	DISPLACEMENT (CM ³)	POWER OUTPUT (KW/HP)	WEIGHT (KG)	ORDER NUMBER	MIN ORDER	RRP INC. GST
HT 56 C-E 25CM/10" Split shaft design  Total length 2.8m	27.2	0.8/1.1	6.4 [^]	4139 200 0013	1	\$799.00
	REPLACEMENT CHAIN LOOP			3670 000 0056	1	\$40.00
	PM3 - 1/4" .043" - 56 DL - 25CM/10"					
HT 135 30CM/12"  Telescopic 2.7m to 3.9m	36.3	1.4/1.9	7.9 [^]	4182 200 0205	1	\$1,699.00
	REPLACEMENT CHAIN LOOP			3670 000 0064	1	\$46.00
	PM3 - 1/4" .043" - 64DL - 30CM/12"					
REPLACEMENT GUIDE BAR			3005 008 3405	1	\$62.00	
1/4" .043" - 30CM/12" - ROLLOMATIC MINI						

*WEIGHT EXCLUDING FUEL, GUIDE BAR & SAW CHAIN

NOTE: TREE SERVICE CHAINSAWS ARE DESIGNED FOR TREE SURGERY WORK & CUTTING IN THE CROWN OF THE STANDING TREE. THE CHAINSAW MUST NOT BE USED FOR CUTTING WORK ON THE GROUND. WARNING ONLY PERSONS WHO HAVE BEEN TRAINED IN THE USE OF A TREE SERVICE CHAINSAW MAY USE THIS CHAINSAW.

	Order number	Rollomatic E bars (bar length, cm/inch ^①)	Displacement (cm ³)	Power output (kW/hp)	Weight (kg) ^②	Power-to-weight ratio (kg/kW)	Sound pressure level ^③ (dB(A))	Sound power level ^④ (dB(A))	Vibration level, left/right ^⑤ (m/s ²)	STIHL engine (2-MIX/4-MIX)
PETROL CHAINSAWS FOR CUTTING FIREWOOD & GROUNDS MAINTENANCE										
MS 162	1148 200 0260	30/12	30.1	1.2/1.6	4.5	3.8	100	111	3.2/3.0	2-MIX
MS 172	1148 200 0267	35/14	31.8	1.4/1.9	4.5	3.2	101	112	3.5/3.2	2-MIX
MS 172 C-BE	1148 200 0268	35/14	31.8	1.4/1.9	4.8	3.5	101	112	3.5/3.2	2-MIX
MS 182	1148 200 0265	40/16	35.8	1.6/2.1	4.6	2.8	103	112	3.1/3.7	2-MIX
MS 182 C-BE	1148 200 0262	40/16	35.8	1.6/2.1	4.9	3.0	103	112	3.1/3.7	2-MIX
MS 212	1148 200 0266	40/16	38.6	1.8/2.4	4.6	2.6	103	113	3.1/3.7	2-MIX
MS 212 C-BE	1148 200 0263	40/16	38.6	1.8/2.4	4.9	2.7	103	113	3.1/3.7	2-MIX
MS 231	1143 200 0727	40/16	42.6	2.0/2.7	4.8	2.4	103	114	3.9/3.9	2-MIX
MS 251	1143 200 0737	45/18	45.6	2.2/3.0	4.8	2.18	103	114	3.9/3.9	2-MIX
MS 251 C-BE	1143 200 0738	45/18	45.6	2.2/3.0	5.1	2.36	103	114	3.9/3.9	2-MIX
PETROL CHAINSAWS FOR AGRICULTURE, HORTICULTURE & THE CONSTRUCTION INDUSTRY										
MS 271	1141 200 0764	45/18	50.2	2.6/3.5	5.6	2.15	103	115	4.5/4.5	2-MIX
MS 291	1141 200 0752	45/18	55.5	2.8/3.8	5.6	2.0	103	116	4.5/4.5	2-MIX
MS 311	1140 200 0695	50/20	59.0	3.1/4.2	6.2	2.0	105	117	4.0/4.0	2-MIX
MS 391	1140 200 0689	50/20	64.1	3.3/4.5	6.2	1.87	105	117	4.0/4.0	2-MIX
PETROL CHAINSAWS FOR FORESTRY WORK										
MS 261 C-M	1141 200 0749	40/16	50.2	3.0/4.1	4.9	1.68	105	116	3.5/3.5	2-MIX
MS 362 C-M	1140 200 0692	50/20	59.0	3.5/4.8	5.6	1.6	105	117	3.5/3.5	2-MIX
MS 400 C-M	1140 200 0475 1140 200 0786	50/20	66.8	4.0/5.4	5.8	1.45	107	118	3.5/3.5	2-MIX
MS 462 C-M Rollomatic ES Light Bar	1142 200 0114	50/20	72.2	3.5/4.8	6.0	1.36	106	119	4.8/3.6	2-MIX
MS 462 C-M	1142 200 0008	50/20	72.2	4.4/6.0	6.0	1.36	108	119	4.8/3.6	2-MIX
MS 500i	1147 200 0021 1147 200 0023 1147 200 0093	50/20 63/25 50/20	79.2	5.0/6.8	6.2	1.28	106	119	4.2/4.0	2-MIX
MS 661 C-M Magnum	1144 200 0332	63/25	91.1	5.4/7.3	7.4	1.37	105	118	6.9/5.6	2-MIX
MS 661 C-M Magnum .404"	1144 200 0348	63/25	91.1	5.4/7.3	7.4	1.37	105	118	6.9/5.6	2-MIX
MS 661 C-M Rollomatic ES Light Bar	1144 200 0334	63/25	91.1	5.4/7.3	7.4	1.37	105	118	6.9/5.6	2-MIX
MS 881	1124 200 0225 1124 200 0226 1124 200 0228 1124 200 0227	63/25 75/30 80/32 90/36	122	6.4/8.7	9.9	1.5	106	118	8.9/8.9	2-MIX

① THE ACTUAL BAR LENGTH IS SHORTER THAN THE STATED BAR LENGTH
 ② WEIGHT EXCLUDING FUEL, GUIDE BAR & SAW CHAIN

③ K FACTOR ACCORDING TO DIR. 2006/42/EC = 2.5 dB(A)
 ④ K FACTOR ACCORDING TO DIR. 2006/42/EC = 2 M/S²

Saw chain pitch	STIHL Oilomatic saw chain type	Lightweight guide bar	Controlled delivery oil pump	Side-mounted chain tensioning	STIHL Quick Chain Tensioning (B)	Manual fuel pump	Decompression valve	STIHL ElastoStart	STIHL Easy2Start (E)	Long-life air filter system	HD2 filter	Tool-free fuel cap	STIHL M-Tronic (M)
3/8" P▲	PMM3	●	-	●	-	-	-	-	-	●	-	-	-
3/8" P▲	PMM3	○	-	●	-	-	-	-	-	●	-	-	-
3/8" P▲	PMM3	○	-	-	●	●	-	-	●	●	-	-	-
3/8" P	PM3	○	-	●	-	-	-	-	-	●	-	●	-
3/8" P	PM3	○	-	-	●	●	-	-	●	●	-	●	-
3/8" P	PM3	○	-	●	-	-	-	-	-	●	-	●	-
3/8" P	PM3	○	-	-	●	●	-	-	●	●	-	●	-
.325"	RM	○	-	●	○	-	-	○	-	●	●	●	-
.325"	RM	○	-	●	○	-	-	○	-	●	●	●	-
.325"	RM	○	-	-	●	●	-	-	●	●	●	●	-
.325"	RM	-	-	●	-	-	-	○	-	●	●	●	-
.325"	RM	-	-	●	-	-	-	○	-	●	●	●	-
3/8"	RM	○	●	●	-	-	-	○	-	●	●	●	-
3/8"	RM	○	●	●	-	-	●	○	-	●	●	●	-
.325"	RM	-	●	●	-	-	●	●	-	●	●	●	●
3/8"	RS	●	●	●	-	-	●	●	-	●	●	●	●
3/8"	RS	●	●	●	-	-	●	●	-	●	●	●	●
3/8"	RS	●	●	●	-	-	●	●	-	●	●	●	●
3/8"	RS	○	●	●	-	-	●	●	-	●	●	●	●
3/8"	RS	●	●	●	-	●	●	●	-	●	●	●	-
3/8"	RS	○	●	●	-	-	●	●	-	●	●	●	●
.404"	RS	-	●	●	-	-	●	●	-	●	●	●	●
3/8"	RS	●	●	●	-	-	●	●	-	●	●	●	●
.404"	RS RS RM RS	○ ○ - ○	●	●	-	-	●	●	-	●	●	●	-

● AS STANDARD
○ RETROFITTABLE (ACCESSORY)

3/8" P▲ PMM3, PICCO MICRO MINI 3A
(NARROW CUTTING ATTACHMENT)

B = QUICK CHAIN TENSIONING
E = EASY2START

M = M-TRONIC

	Order number	Rollomatic E bars (bar length, cm / inch [ⓐ])	Displacement (cm ¹)	Power output (kW/hp)	Rated voltage (V)	Power consumption (kW)	Weight (kg)	Power-to-weight ratio (kg/kW)	Sound pressure level [ⓑ] (dB(A))	Sound power level [ⓑ] (dB(A))	Vibration level, left / right [ⓐ] (m/s ²)
ARBORIST SAWS											
MS 151 TC-E	1146 200 0064	30/12	23.6	1.0/1.4	-	-	2.6 [ⓐ]	2.6	96	109	4.9/4.9
MS 194 T	1137 200 0418	30/12	31.8	1.4/1.9	-	-	3.3 [ⓐ]	2.53	100	112	3.6/3.6
MS 201 TC-M	1145 200 0335 1145 200 0334	30/12 35/14	35.2	1.8/2.4	-	-	3.7 [ⓐ]	2.05	100	113	3.5/3.1
MSA 161 T	1252 200 0044	30/12	-	-	36	-	2.1 [ⓐ]	-	83	94	2.2/2.1
NEW MSA 190 T	MA05 200 0042	30/12	-	-	36	-	2.6 [ⓐ]	-	91	99	3.9/3.8
MSA 220 T	MA01 200 0044 MA01 200 0045	30/12 35/14	-	-	36	-	2.7 [ⓐ]	-	94	104	3.4/3.0
MSA 220 TC-O	MA01 200 0046 MA01 200 0047	30/12 35/14	-	-	36	-	2.7 [ⓐ]	-	94	104	3.4/3.0
EMERGENCY SERVICES SAW											
MS 462 C-M R	1142 200 0133	50/20	72.2	4.4/6.0	-	-	6.5 [ⓐ]	1.47	108	119	3.3/2.7
BATTERY CHAINSAWS											
MSA 60 C-B	MA04 011 5800	30/12	-	-	36	-	2.6 [ⓐ]	-	83	94	3.4/3.2
MSA 70 C-B	MA04 011 5816	30/12	-	-	36	-	2.7 [ⓐ]	-	83	94	4.3/4.8
MSA 80 C-B	MA04 011 5843	35/14	-	-	36	-	2.9 [ⓐ]	-	85	93	3.9 / 4.6
MSA 160 C-B	MA03 200 0004	30/12	-	-	36	-	3.1 [ⓐ]	-	84	95	2.7/2.9
MSA 200 C-B	MA03 200 0010	35/14	-	-	36	-	3.3 [ⓐ]	-	84	95	4.6/3.9
MSA 220 C-B	MA03 200 0020 MA03 200 0021	35/14 40/16	-	-	36	-	3.6/3.7 [ⓐ]	-	89	100	4.8/3.6
MSA 300 C-O	MA02 200 0024 MA02 200 0062 MA02 200 0027 MA02 200 0029	40/16 40/16 45/18 50/20	-	-	36	-	5.4 [ⓐ]	-	93	104	2.6/2.8
ELECTRIC CHAINSAWS											
MSE 141 C	1208 200 0342	30/12	-	-	240	1.4	4.1 [ⓐ]	-	90	101	3.3/4.2
MSE 170 C-B	1209 200 0050	35/14	-	-	240	1.7	4.3 [ⓐ]	-	92	103	2.9/3.4
PETROL POLE PRUNERS											
HT 56 C-E	4139 200 0013	25/10	27.2	0.8/1.09	-	-	6.7 [ⓐ]	-	91	107	6.2/5.4
HT 135	4182 200 0205	30/12	36.3	1.4/1.9	-	-	7.9 [ⓐ]	-	93	109	3.6/4.3 [ⓐ]
BATTERY POLE PRUNERS											
NEW HTA 30	LA05 011 6400	20/8	-	-	21.6	-	3.2 [ⓐ]	-	80	91	0.5/0.6
HTA 50	LA02 011 6400	25/10	-	-	36	-	3.6	-	78	94	0.5/1.0
HTA 86	LA03 200 0002	30/12	-	-	36	-	4.6	-	77	93	1.0/ 1.0
HTA 135	LA01 200 0044	30/12	-	-	36	-	6.8	-	85	96	4.3/ 5.1
HTA 160	LA01 200 0033	30/12	-	-	36	-	6.9	-	85	97	4.1/ 5.6

[ⓐ] THE ACTUAL BAR LENGTH IS SHORTER THAN THE STATED BAR LENGTH

[ⓑ] K FACTOR ACCORDING TO DIR. 2006/42/EC = 2.5 dB(A)

[ⓒ] K FACTOR ACCORDING TO DIR. 2006/42/EC = 2 M/S²

[ⓓ] WEIGHT EXCLUDING FUEL, GUIDE BAR & SAW CHAIN

[ⓐ] WEIGHT EXCLUDING BATTERY, INCLUDING GUIDE BAR & SAW CHAIN

[ⓑ] WEIGHT INCLUDING BATTERY, GUIDE BAR & SAW CHAIN

[ⓒ] WEIGHT EXCLUDING CABLE & CHAIN OIL, INCLUDING GUIDE BAR & SAW CHAIN

[ⓓ] WITH SHAFT COMPRESSED

STIHL engine (2-MIX/4-MIX)	Cable length (m)	Saw chain pitch	STIHL Oilomatic saw chain type	Total length with cutting attachment (cm)	Lightweight guide bar	Controlled-delivery oil pump	Side-mounted chain tensioning	STIHL Quick Chain Tensioning (B)	QuickStop Super chain brake	Manual fuel pump	Decompression valve	STIHL ElastoStart	STIHL Easy2Start (E)	HD2 filter	Tool-free fuel cap	STIHL M-Tronic (M)	Tool-free oil tank cap	Overload protection	Soft handle	Automatic decompression	Oil sensor
2-MIX	-	1/4" P	PM3	-	-	-	●	-	-	●	-	-	●	-	●	-	●	-	-	-	-
2-MIX	-	3/8" P▲	PMM3	-	○	●	●	-	-	●	-	○	-	-	●	-	●	-	-	-	-
2-MIX	-	3/8" P	PS	-	●	●	●	-	-	-	-	●	-	-	●	●	●	-	-	-	-
-	-	1/4" P	PM3	-	-	-	●	-	●	-	-	-	-	-	-	-	●	●	●	-	-
-	-	3/8" P	PS3	-	●	●	●	-	●	-	-	-	-	-	-	-	●	-	-	-	-
-	-	3/8" P	PS	-	○	●	●	-	●	-	-	-	-	-	-	-	●	-	●	-	-
-	-	3/8" P	PS	-	○	●	●	-	●	-	-	-	-	-	-	-	●	-	●	-	●
2-MIX	-	3/8" P	RDR	-	-	●	●	-	-	-	●	-	-	●	●	●	●	-	-	-	-
-	-	1/4" P	PM3	-	-	-	-	●	●	-	-	-	-	-	-	-	-	●	●	-	-
-	-	1/4" P	PM3	-	-	-	-	●	●	-	-	-	-	-	-	-	-	●	●	-	-
-	-	1/4" P	PM3	-	-	-	-	●	●	-	-	-	-	-	-	-	-	●	●	-	-
-	-	1/4" P	PM3	-	-	-	-	●	●	-	-	-	-	-	-	-	●	●	●	-	-
-	-	1/4" P	PM3	-	-	-	-	●	●	-	-	-	-	-	-	-	●	●	●	-	-
-	-	3/8" P	PM3	-	-	-	-	●	●	-	-	-	-	-	-	-	●	●	●	-	-
-	-	.325"	RS3	-	○	●	●	-	●	-	-	-	-	-	-	-	●	-	●	-	●
-	0.4	3/8" P▲	PMM3	-	-	-	●	-	-	-	-	-	-	-	-	-	-	●	-	-	-
-	4.0	3/8" P▲	PMM3	-	○	-	-	●	●	-	-	-	-	-	-	-	●	●	●	-	-
2-MIX	-	1/4" P	PM3	280	-	-	●	-	-	●	-	-	●	-	-	-	●	-	●	-	-
4-MIX	-	1/4" P	PM3	390	-	-	●	-	-	●	-	●	-	-	-	-	●	-	-	●	-
-	-	1/4" P	PM3	280	●	●	-	●	-	-	-	-	-	-	-	-	-	-	●	-	-
-	-	1/4" P	PM3	280	○	●	●	-	●	-	-	-	-	-	-	-	-	-	●	-	-
-	-	1/4" P	PM3	270-390	-	-	●	-	-	-	-	-	-	-	-	-	●	●	●	-	-
-	-	1/4" P	PM3	285-405	-	-	●	-	-	-	-	-	-	-	-	-	●	●	●	-	-
-	-	1/4" P	PM3	285-405	-	-	●	-	-	-	-	-	-	-	-	-	●	●	●	-	-

● AS STANDARD
○ RETROFITTABLE (ACCESSORY)

3/8" P▲ PMM3; PICCO MICRO MINI 3 (NARROW CUTTING ATTACHMENT)

B = QUICK CHAIN TENSIONING
E = EASY2START

M = M-TRONIC
T = TOP HANDLE

CHAIN LOOPS

TYPE	PITCH (INCHES)	GAUGE (INCHES)	DRIVE LINKS	BAR LENGTH	SPECIAL FEATURE	ORDER NUMBER	CASE QTY	RRP INC. GST
1/4" .043 RAPID MICRO SEMI CHISEL (3) LOW KICKBACK								
71PM3	1/4"P	.043"	28DL	10CM/4"	PICCO MICRO	3670 000 0028	40	\$25.00
71PM3	1/4"P	.043"	38DL	15CM/5"	PICCO MICRO	3670 000 0038	40	\$32.00
71PM3	1/4"P	.043"	44DL	20CM/8"	PICCO MICRO	3670 000 0044	40	\$TBC
71PM3	1/4"P	.043"	65DL	30CM/12"	PICCO MICRO	3670 000 0065	40	\$51.00
71PM3	1/4"P	.043"	56DL	25CM/10"	PICCO MICRO	3670 000 0056	40	\$40.00
71PM3	1/4"P	.043"	64DL	30CM/12"	PICCO MICRO	3670 000 0064	40	\$46.00
71PM3	1/4"P	.043"	72DL	35CM/14"	PICCO MICRO	3670 000 0072	40	\$54.00
1/4" .050 RAPID MICRO SPECIAL SEMI CHISEL CARVING								
13RMS	1/4"	.050"	56DL	25CM/10"	RAPID MICRO	3661 000 0056	40	\$61.00
13RMS	1/4"	.050"	64DL	30CM/12"	RAPID MICRO	3661 000 0064	40	\$61.00
3/8PMM3 .043 PICCO MICRO MINI SEMI CHISEL (3) LOW KICKBACK								
61PMM3	3/8"P	.043"	44DL	30CM/12"	PICCO MICRO MINI	3610 000 0044	40	\$34.00
61PMM3	3/8"P	.043"	50DL	35CM/14"	PICCO MICRO MINI	3610 000 0050	40	\$39.00
61PMM3	3/8"P	.043"	51DL	35CM/14"	PICCO MICRO MINI	3610 000 0051	40	\$39.00
61PMM3	3/8"P	.043"	55DL	40CM/16"	PICCO MICRO MINI	3610 000 0055	20	\$42.00
3/8P .050 PICCO MICRO SEMI CHISEL								
63PM	3/8"P	.050"	44DL	30CM/12"	PICCO MICRO	3613 000 0044	40	\$31.00
63PM	3/8"P	.050"	50DL	35CM/14"	PICCO MICRO	3613 000 0050	20	\$39.00
63PM	3/8"P	.050"	56DL	40CM/16"	PICCO MICRO	3613 000 0055	20	\$42.00
3/8P .050 PICCO MICRO SEMI CHISEL (3) LOW KICKBACK								
63PM3	3/8"P	.050"	44DL	30CM/12"	PICCO MICRO	3636 000 0044	40	\$31.00
63PM3	3/8"P	.050"	50DL	35CM/14"	PICCO MICRO	3636 000 0050	20	\$36.00
63PM3	3/8"P	.050"	55DL	40CM/16"	PICCO MICRO	3636 000 0055	20	\$40.00
3/8P .050 PICCO SUPER FULL CHISEL								
63PS	3/8"P	.050"	44DL	30CM/12"	PICCO MICRO	3617 000 0044	40	\$34.00
63PS	3/8"P	.050"	50DL	35CM/14"	PICCO SUPER	3617 000 0050	20	\$36.00
63PS	3/8"P	.050"	55DL	40CM/16"	PICCO SUPER	3617 000 0055	20	\$40.00
63PS	3/8"P	.050"	60DL	40CM/16"	PICCO SUPER	3617 000 0060	20	\$42.00
3/8P .050 PICCO SUPER FULL CHISEL (3) LOW KICKBACK								
63PS3	3/8"P	.050"	44DL	30CM/12"	PICCO SUPER	3616 000 0044	40	\$34.00
63PS3	3/8"P	.050"	50DL	35CM/14"	PICCO SUPER	3616 000 0050	20	\$39.00
63PS3	3/8"P	.050"	55DL	40CM/16"	PICCO SUPER	3616 000 0055	20	\$42.00
.325 .050 RAPID MICRO SEMI CHISEL								
23RM	.325"	.050"	78DL	50CM/20"	RAPID MICRO	3684 000 0078	20	\$46.00
.325 .063 RAPID SUPER FULL CHISEL								
26RS	.325"	.063"	56DL	35CM/14"	RAPID SUPER	3639 000 0056	20	\$39.00
26RS	.325"	.063"	62DL	38CM/15"	RAPID SUPER	3639 000 0062	20	\$44.00
26RS	.325"	.063"	67DL	40CM/16"	RAPID SUPER	3639 000 0067	20	\$50.00
26RS	.325"	.063"	68DL	45CM/18"	RAPID SUPER	3639 000 0068	20	\$50.00
26RS	.325"	.063"	74DL	45CM/18"	RAPID SUPER	3639 000 0074	20	\$54.00
26RS	.325"	.063"	81DL	50CM/20"	RAPID SUPER	3639 000 0081	20	\$56.00

CHAIN LOOPS

TYPE	PITCH (INCHES)	GAUGE (INCHES)	DRIVE LINKS	BAR LENGTH	SPECIAL FEATURE	ORDER NUMBER	CASE QTY	RRP INC. GST
.325 .063 RAPID MICRO SEMI CHISEL								
26RM	.325"	.063"	56DL	35CM/14"	RAPID MICRO	3686 000 0056	20	\$42.00
26RM	.325"	.063"	62DL	40CM/16"	RAPID MICRO	3686 000 0062	20	\$44.00
26RM	.325"	.063"	67DL	40CM/16"	RAPID MICRO	3686 000 0067	20	\$46.00
26RM	.325"	.063"	68DL	45CM/18"	RAPID MICRO	3686 000 0068	20	\$49.00
26RM	.325"	.063"	74DL	45CM/18"	RAPID MICRO	3686 000 0074	20	\$50.00
3/8 .050 RAPID SUPER FULL CHISEL								
33RS	3/8"	.050"	60DL	40CM/16"	RAPID SUPER	3623 000 0060	20	\$50.00
33RS	3/8"	.050"	71DL	50CM/20"	RAPID SUPER	3623 000 0071	20	\$54.00
3/8 .063 RAPID MICRO SEMI CHISEL								
36RM	3/8"	.063"	60DL	40CM/16"	RAPID MICRO	3652 000 0060	20	\$50.00
36RM	3/8"	.063"	66DL	45CM/18"	RAPID MICRO	3652 000 0066	20	\$50.00
36RM	3/8"	.063"	72DL	50CM/20"	RAPID MICRO	3652 000 0072	20	\$56.00
36RM	3/8"	.063"	84DL	63CM/25"	RAPID MICRO	3652 000 0084	20	\$61.00
36RM	3/8"	.063"	85DL	63CM/25"	RAPID MICRO	3652 000 0085	20	\$61.00
36RM	3/8"	.063"	98DL	76CM/30"	RAPID MICRO	3652 000 0098	12	\$72.00
3/8 .063 RAPID SUPER FULL CHISEL								
36RS	3/8"	.063"	60DL	40CM/16"	RAPID SUPER	3621 000 0060	20	\$50.00
36RS	3/8"	.063"	66DL	45CM/18"	RAPID SUPER	3621 000 0066	20	\$50.00
36RS	3/8"	.063"	72DL	50CM/20"	RAPID SUPER	3621 000 0072	20	\$56.00
36RS	3/8"	.063"	76DL	56CM/22"	RAPID SUPER	3621 000 0076	20	\$56.00
36RS	3/8"	.063"	84DL	63CM/25"	RAPID SUPER	3621 000 0084	20	\$61.00
36RS	3/8"	.063"	85DL	63CM/25"	RAPID SUPER	3621 000 0085	20	\$61.00
36RS	3/8"	.063"	91DL	71CM/28"	RAPID SUPER	3621 000 0091	20	\$61.00
36RS	3/8"	.063"	98DL	76CM/30"	RAPID SUPER	3621 000 0098	12	\$67.00
36RS	3/8"	.063"	105DL	79CM/31"	RAPID SUPER	3621 000 0105	12	\$77.00
36RS	3/8"	.063"	114DL	91CM/36"	RAPID SUPER	3621 000 0114	12	\$77.00
3/8 .063 RAPID SUPER KLASSIK 30° FULL CHISEL								
36RSK	3/8"	.063"	56DL	33CM/13"	RAPID SUPER KLASSIK	3898 000 0056	20	\$46.00
36RSK	3/8"	.063"	72DL	50CM/20"	RAPID SUPER KLASSIK	3898 000 0072	20	\$51.00
36RSK	3/8"	.063"	84DL	63CM/25"	RAPID SUPER KLASSIK	3898 000 0084	20	\$61.00
.404 .063 RAPID MICRO SEMI CHISEL								
46RM	.404	.063"	77DL	53CM/21"	RAPID MICRO	3668 000 0077	20	\$72.00
46RM	.404	.063"	92DL	75CM/30"	RAPID MICRO	3668 000 0092	12	\$77.00
.404 .063 RAPID SUPER FULL CHISEL								
46RS	.404"	.063"	72DL	60CM/24"	RAPID SUPER	3946 000 0072	20	\$61.00
46RS	.404"	.063"	80DL	63CM/25"	RAPID SUPER	3946 000 0080	20	\$67.00
46RS	.404"	.063"	84DL	70CM/28"	RAPID SUPER	3946 000 0084	20	\$67.00
46RS	.404"	.063"	173DL	150CM/59"	RAPID SUPER	3946 000 0173	12	\$133.00
.404 .063 RAPID CHIPPER RIPPING 10° SEMI CHISEL								
46RCX	.404	.063"	104DL	91CM/36"	RAPID RIPPING	3958 000 0104	12	\$82.00
46RCX	.404	.063"	139DL	120CM/47"	RAPID RIPPING	3958 000 0139	12	\$103.00

CHAIN LOOPS FOR PROFESSIONAL USE

TYPE	PITCH (INCHES)	GAUGE (INCHES)	DRIVE LINKS	BAR LENGTH	SPECIAL FEATURE	ORDER NUMBER	CASE QTY	RRP INC. GST
3/8 .043 PRO PICCO SUPER FULL CHISEL (3) LOW KICKBACK								
61PS3	3/8"	.043"	44DL	30CM/12"	PRO PICCO SUPER	3699 000 0044	40	\$36.00
61PS3	3/8"	.043"	45DL	30CM/12"	PRO PICCO SUPER	3699 000 0045	40	\$36.00
61PS3	3/8"	.043"	50DL	35CM/14"	PRO PICCO SUPER	3699 000 0050	40	\$36.00
61PS3	3/8"	.043"	51DL	35CM/14"	PRO PICCO SUPER	3699 000 0051	40	\$39.00
61PS3	3/8"	.043"	55DL	40CM/16"	PRO PICCO SUPER	3699 000 0055	20	\$42.00
61PS3	3/8"	.043"	56DL	40CM/16"	PRO PICCO SUPER	3699 000 0056	20	\$42.00
61PS3	3/8"	.043"	61DL	45CM/18"	PRO PICCO SUPER	3699 000 0061	20	\$45.00
61PS3	3/8"	.043"	62DL	40CM/16"	PRO PICCO SUPER	3699 000 0062	20	\$45.00
.325 .050 PRO RAPID MICRO SEMI CHISEL								
23RM	.325"	.050"	62DL	40CM/16"	PRO RAPID MICRO	3693 000 0062	20	\$44.00
23RM	.325"	.050"	64DL	38CM/15"	PRO RAPID MICRO	3693 000 0064	20	\$42.00
23RM	.325"	.050"	66DL	40CM/16"	PRO RAPID MICRO	3693 000 0066	20	\$44.00
23RM	.325"	.050"	68DL	45CM/18"	PRO RAPID MICRO	3693 000 0068	20	\$49.00
23RM	.325"	.050"	72DL	45CM/18"	PRO RAPID MICRO	3693 000 0072	20	\$49.00
23RM	.325"	.050"	74DL	45CM/18"	PRO RAPID MICRO	3693 000 0074	20	\$50.00
23RM	.325"	.050"	78DL	50CM/20"	PRO RAPID MICRO	3693 000 0078	20	\$50.00
.325 .050 PRO RAPID SUPER FULL CHISEL								
23RS	.325"	.050"	60DL	35CM/14"	PRO RAPID SUPER	3690 000 0060	20	\$43.00
23RS	.325"	.050"	67DL	40CM/16"	PRO RAPID SUPER	3690 000 0067	20	\$48.00
23RS	.325"	.050"	74DL	45CM/18"	PRO RAPID SUPER	3690 000 0074	20	\$50.00
23RS	.325"	.050"	81DL	50CM/20"	PRO RAPID SUPER	3690 000 0081	20	\$54.00

DURO CARBIDE CHAIN LOOPS

TYPE	PITCH (INCHES)	GAUGE (INCHES)	DRIVE LINKS	BAR LENGTH	SPECIAL FEATURE	ORDER NUMBER	CASE QTY	RRP INC. GST
3/8 .050 PICCO DURO CARBIDE (3) LOW KICKBACK								
63PD3	3/8"P	.050"	44DL	30CM/12"	PICCO DURO	3612 000 0044	40	\$72.00
63PD3	3/8"P	.050"	50DL	35CM/14"	PICCO DURO	3612 000 0050	20	\$77.00
63PD3	3/8"P	.050"	55DL	40CM/16"	PICCO DURO	3612 000 0055	20	\$87.00
.325 .050 RAPID DURO PRO (3) LOW KICKBACK								
23RD3 PRO	.325"	.050"	56DL	35CM/14"	RAPID DURO	3696 000 0056	20	\$97.00
23RD3 PRO	.325"	.050"	62DL	40CM/16"	RAPID DURO	3696 000 0062	20	\$115.00
23RD3 PRO	.325"	.050"	66DL	40CM/16"	RAPID DURO	3696 000 0066	20	\$123.00
23RD3 PRO	.325"	.050"	67DL	45CM/14"	RAPID DURO	3696 000 0067	20	\$125.00
23RD3 PRO	.325"	.050"	68DL	45CM/18"	RAPID DURO	3696 000 0068	20	\$TBC
23RD3 PRO	.325"	.050"	72DL	45CM/18"	RAPID DURO	3696 000 0072	20	\$134.00
23RD3 PRO	.325"	.050"	74DL	45CM/18"	RAPID DURO	3696 000 0074	20	\$138.00
3/8 .063 RAPID DURO CARBIDE (3) LOW KICKBACK								
36RD3	3/8"	.063"	60DL	40CM/16"	RAPID DURO	3683 000 0060	20	\$215.00
36RD3	3/8"	.063"	66DL	45CM/18"	RAPID DURO	3683 000 0066	20	\$225.00
36RD3	3/8"	.063"	72DL	50CM/20"	RAPID DURO	3683 000 0072	20	\$256.00
36RD3	3/8"	.063"	76DL	56CM/22"	RAPID DURO	3683 000 0076	20	\$256.00
36RD3	3/8"	.063"	84DL	63CM/25"	RAPID DURO	3683 000 0084	20	\$286.00
36RD3	3/8"	.063"	98DL	76CM/30"	RAPID DURO	3683 000 0098	20	\$347.00

HEXA CHAIN, REELS & KITS

TYPE	PITCH	GAUGE	DRIVE LINKS	BAR LENGTH	SPECIAL FEATURE	ORDER NUMBER	MIN ORDER	BOX QTY	RRP INC. GST
3/8 .063 RAPID HEXA FULL CHISEL									
36RH	3/8"	.063"	60DL	40CM/16"	RAPID HEXA	3132 000 0060	1	20	\$45.00
36RH	3/8"	.063"	66DL	45CM/18"	RAPID HEXA	3132 000 0066	1	20	\$50.00
36RH	3/8"	.063"	72DL	50CM/20"	RAPID HEXA	3132 000 0072	1	20	\$55.00
36RH	3/8"	.063"	84DL	63CM/25"	RAPID HEXA	3132 000 0084	1	20	\$60.00
36RH	3/8"	.063"	91DL	71CM/28"	RAPID HEXA	3132 000 0091	1	20	\$60.00
36RH	3/8"	.063"	98DL	76CM/30"	RAPID HEXA	3132 000 0098	1	20	\$65.00
36RH	3/8"	.063"	114DL	91CM/36"	RAPID HEXA	3132 000 0114	1	20	\$75.00
36RH	3/8"	.063"	410DL	25FT	RAPID HEXA	3132 000 0410	1	—	\$275.00
36RH	3/8"	.063"	1640DL	100FT	RAPID HEXA	3132 000 1640	1	—	\$1000.00

HEXA UPGRADE KITS

TYPE	PITCH	GAUGE	DRIVE LINKS	BAR LENGTH	SPECIAL FEATURE	ORDER NUMBER	MIN ORDER	RRP INC. GST	
3/8 .063 RAPID HEXA FULL CHISEL UPGRADE KIT									
36RH60	3/8	.063"	2x 60DL	40CM/16"	HEXA KIT	3132 007 4700	1	\$95.00	
36RH66	3/8"	.063"	2X 66DL	45CM/18"	HEXA KIT	3132 007 4701	1	\$100.00	
36RH72	3/8"	.063"	2X 72DL	50CM/20"	HEXA KIT	3132 007 4702	1	\$110.00	
36RH84	3/8"	.063"	2X 84DL	63CM/25"	HEXA KIT	3132 007 4703	1	\$120.00	



i KITS CONTAIN: 2X LOOPS OF CHAIN, 1X HEXA FILE & 1X WOODEN FILE HANDLE
NOTE: REFER TO SSC FOR BAR & CHAIN COMBINATIONS

CHAIN REELS

TYPE	PITCH	GAUGE	DRIVE LINKS	LENGTH	SPECIAL FEATURE	ORDER NUMBER	MIN ORDER	RRP INC. GST	
1/4" .043 RAPID MICRO SEMI CHISEL (3) LOW KICKBACK									
71PM3	1/4"	.043"	600DL	25FT	PICCO MICRO	3670 000 0600	1	\$368.00	
1/4" .050 RAPID MICRO SEMI CHISEL									
13RM	1/4"	.050"	600DL	25FT	RAPID MICRO	3660 000 0600	1	\$419.00	
1/4" .050 RAPID MICRO SPECIAL SEMI CHISEL CARVING									
13RMS	1/4"	.050"	2400DL	100FT	RAPID MICRO	3661 000 2400	1	\$1950.00	
3/8" .043 PICCO MINI MICRO SEMI CHISEL (3) LOW KICK BACK									
61PMM3	3/8"P	.043"	410DL	25FT	PICCO MINI MICRO	3610 000 0410	1	\$235.00	
61PMM3	3/8"P	.043"	1640DL	100FT	PICCO MINI MICRO	3610 000 1640	1	\$827.00	
3/8" .050 PICCO MICRO SEMI CHISEL									
63PM	3/8"P	.050"	410DL	25FT	PICCO MICRO	3613 000 0410	1	\$256.00	
63PM	3/8"P	.050"	1640DL	100FT	PICCO MICRO	3613 000 1640	1	\$857.00	
3/8" .050 PICCO MICRO SEMI CHISEL (3) LOW KICK BACK									
63PM3	3/8"P	.050"	410DL	25FT	PICCO MICRO	3636 000 0410	1	\$256.00	
3/8" .050 PICCO SUPER FULL CHISEL									
63PS	3/8"P	.050"	410DL	25FT	PICCO SUPER	3617 000 0410	1	\$256.00	
63PS	3/8"P	.050"	1640DL	100FT	PICCO SUPER	3617 000 1640	1	\$883.00	

CHAIN REELS

TYPE	PITCH	GAUGE	DRIVE LINKS	LENGTH	SPECIAL FEATURE	ORDER NUMBER	MIN ORDER	RRP INC. GST
3/8P .050 PICCO SUPER FULL CHISEL (3) LOW KICKBACK								
63PS3	3/8"P	.050"	410DL	25FT	PICCO SUPER	3616 000 0410	1	\$256.00
63PS3	3/8"P	.050"	1640DL	100FT	PICCO SUPER	3616 000 1640	1	\$883.00
3/8P .050 PICCO DURO (3) LOW KICKBACK								
63PD3	3/8"P	.050"	410DL	25FT	PICCO DURO	3612 000 0410	1	\$689.00
3/8P .050 PICCO MICRO (X) RIPPING CHAIN								
63PMX	3/8"P	.050"	1640DL	100FT	PICCO RIPPING MICRO	3614 000 1640	1	\$827.00
.325 .058 RAPID MICRO SEMI CHISEL								
25RM	.325"	.058"	460DL	25FT	RAPID MICRO	3685 000 0460	1	\$276.00
25RM	.325"	.058"	1840DL	100FT	RAPID MICRO	3685 000 1840	1	\$959.00
.325 .058 RAPID SUPER FULL CHISEL								
26RS	.325"	.058"	460DL	25FT	RAPID SUPER	3638 000 0460	1	\$276.00
.325 .058 RAPID DURO (3) LOW KICK BACK								
25RD3	.325"	.058"	460DL	25FT	RAPID DURO	3666 000 0460	1	\$771.00
.325 .063 RAPID MICRO SEMI CHISEL								
26RM	.325"	.063"	460DL	25FT	RAPID MICRO	3686 000 0460	1	\$276.00
26RM	.325"	.063"	1840DL	100FT	RAPID MICRO	3686 000 1840	1	\$959.00
.325 .063 RAPID MICRO SEMI CHISEL								
26RS	.325"	.063"	1840DL	100FT	RAPID MICRO	3639 000 1840	1	\$959.00
3/8 .050 RAPID MICRO SEMI CHISEL								
33RM	3/8"	.050"	410DL	25FT	RAPID MICRO	3650 000 0410	1	\$276.00
33RM	3/8"	.050"	1640DL	100FT	RAPID MICRO	3650 000 1640	1	\$959.00
3/8 .050 RAPID SUPER FULL CHISEL								
33RS	3/8"	.050"	410DL	25FT	RAPID SUPER	3623 000 0410	1	\$276.00
3/8 .050 RAPID SUPER FULL CHISEL (3) LOW KICK BACK								
33RS3	3/8"	.050"	410DL	25FT	RAPID SUPER	3624 000 0410	1	\$276.00
3/8 .058 RAPID MICRO SEMI CHISEL								
35RM	3/8"	.058"	410DL	25FT	RAPID MICRO	3651 000 0410	1	\$276.00
35RM	3/8"	.058"	1640DL	100FT	RAPID MICRO	3651 000 1640	1	\$959.00
3/8 .058 RAPID SUPER FULL CHISEL								
35RS	3/8"	.058"	410DL	25FT	RAPID SUPER	3622 000 0410	1	\$276.00
35RS	3/8"	.058"	1640DL	100FT	RAPID SUPER	3622 000 1640	1	\$959.00
3/8 .063 RAPID MICRO SEMI CHISEL								
35RM	3/8"	.063"	410DL	25FT	RAPID MICRO	3652 000 0410	1	\$276.00
35RM	3/8"	.063"	1640DL	100FT	RAPID MICRO	3652 000 1640	1	\$959.00
3/8 .063 RAPID SUPER FULL CHISEL								
36RS	3/8"	.063"	410DL	25FT	RAPID SUPER	3621 000 0410	1	\$276.00
36RS	3/8"	.063"	1640DL	100FT	RAPID SUPER	3621 000 1640	1	\$959.00
3/8 .063 RAPID DURO (3) LOW KICKBACK								
36RD3	3/8"	.063"	410DL	25FT	RAPID DURO	3683 000 0410	1	\$1,398.00
3/8 .063 RAPID MICRO (X) RIPPING 10°								
36RMX	3/8"	.063"	410DL	25FT	RIPPING	3653 000 0410	1	\$256.00

CHAIN REELS

TYPE	PITCH	GAUGE	DRIVE LINKS	LENGTH	SPECIAL FEATURE	ORDER NUMBER	MIN ORDER	RRP INC. GST
3/8 .063 RAPID SUPER (L) SQUARE GROUND (F) FULL SKIP 30°								
36RSLF	3/8"	.063"	410DL	25FT	SQUARE SKIP TOOTH	3673 000 0410	1	\$276.00
36RSLF	3/8"	.063"	1640DL	100FT	SQUARE SKIP TOOTH	3673 000 1640	1	\$959.00
3/8 .063 RAPID SUPER FULL CHISEL (K) KLASSIK								
36RSK	3/8"	.063"	1640DL	100FT	RAPID SUPER	3898 000 1640	1	\$1,148.00
.404 .058 RAPID SUPER (F) FULL SKIP								
45RSF	.404"	.058"	370DL	25FT	RAPID SUPER	3924 000 0370	1	\$276.00
45RSF	.404"	.058"	1480DL	100FT	RAPID SUPER	3924 000 1480	1	\$899.00
.404 .063 RAPID MICRO SEMI CHISEL								
46RM	.404"	.063"	370DL	25FT	RAPID MICRO	3668 000 0370	1	\$276.00
46RM	.404"	.063"	1480DL	100FT	RAPID MICRO	3668 000 1480	1	\$959.00
.404 .063 RAPID SUPER FULL CHISEL								
46RS	.404"	.063"	370DL	25FT	RAPID SUPER	3946 000 0370	1	\$276.00
46RS	.404"	.063"	1480DL	100FT	RAPID SUPER	3946 000 1480	1	\$959.00
.404 .063 RAPID MICRO (X) RIPPING 10°								
46RMX	.404"	.063"	1480DL	100FT	RAPID MICRO RIPPING	3838 000 1480	1	\$999.00
.404 .063 RAPID MICRO SEMI CHISEL (F) FULL SKIP								
46RMF	.404"	.063"	370DL	25FT	RAPID MICRO FULL SKIP	3671 000 0370	1	\$276.00
46RMF	.404"	.063"	1480DL	100FT	RAPID MICRO	3671 000 1480	1	\$959.00
.404 .063 RAPID MICRO (H) SEMI CHISEL HARVESTER								
46RMH	.404"	.063"	1480DL	100FT	RAPID MICRO	3995 000 1480	1	\$1,070.00
.404 .063 RAPID SUPER (L) SQUARE GROUND (F) FULL SKIP 30°								
46RSLF	.404"	.063"	370DL	25FT	SQUARE SKIP TOOTH	3851 000 0370	1	\$276.00
46RSLF	.404"	.063"	1480DL	100FT	SQUARE SKIP TOOTH	3851 000 1480	1	\$1,031.00
.404 .063 RAPID RIPPING SEMI CHISEL (X) FULL SKIP								
46RCX	.404"	.063"	370DL	25FT	RAPID RIPPING	3958 000 0370	1	\$276.00
46RCX	.404"	.063"	1480DL	100FT	RAPID RIPPING	3958 000 1480	1	\$959.00
.404 .080 RAPID MICRO (H) SEMI CHISEL HARVESTER								
40RMH	.404"	.080"	1480DL	100FT	RAPID MICRO	3996 000 1480	1	\$1,143.00
.404 .080 RAPID MICRO (HS) HARVESTER SPECIAL								
40RMHS	.404"	.080"	740DL	50FT	HARVESTER	3620 000 0740	1	\$653.00

CHAIN REELS FOR FARMING AND PROFESSIONAL USE

TYPE	PITCH	GAUGE	DRIVE LINKS	LENGTH	SPECIAL FEATURE	ORDER NUMBER	MIN ORDER	RRP INC. GST
3/8P .043 PICCO SUPER PRO FULL CHISEL (3) LOW KICKBACK								
61PS3 PRO	3/8"	0.043	410DL	25FT	PICCO SUPER PRO	3699 000 0410	1	\$235.00
61PS3 PRO	3/8"	0.043	1640DL	100FT	PICCO SUPER PRO	3699 000 1640	1	\$827.00
.325 .050 RAPID MICRO PRO SEMI CHISEL								
23RM PRO	.325"	.050"	460DL	25FT	RAPID MICRO PRO	3693 000 0460	1	\$319.00
23RM PRO	.325"	.050"	1840DL	100FT	RAPID MICRO PRO	3693 000 1840	1	\$999.00
.325 .050 RAPID MICRO PRO SEMI CHISEL (3) LOW KICKBACK								
23RM3 PRO	.325"	.050"	460DL	25FT	RAPID MICRO PRO	3695 000 0460	1	\$319.00
23RM3 PRO	.325"	.050"	1840DL	100FT	RAPID MICRO PRO	3695 000 1840	1	\$999.00
.325 .050 RAPID SUPER PRO SEMI CHISEL (3) LOW KICKBACK								
23RS3 PRO	.325"	.050"	460DL	25FT	RAPID SUPER PRO	3694 000 0460	1	\$319.00
23RS3 PRO	.325"	.050"	1840DL	100FT	RAPID SUPER PRO	3694 000 1840	1	\$999.00
.325 .050 RAPID SUPER PRO FULL CHISEL								
23RS PRO	.325"	.050"	460DL	25FT	RAPID SUPER PRO	3690 000 0460	1	\$319.00
23RS PRO	.325"	.050"	1840DL	100FT	RAPID SUPER PRO	3690 000 1840	1	\$999.00
.325 .050 RAPID DURO PRO (3) LOW KICKBACK								
23RD3 PRO	.325"	.050"	460DL	25FT	RAPID DURO PRO	3696 000 0460	1	\$799.00
23RD3 PRO	.325"	.050"	1840DL	100FT	RAPID DURO PRO	3696 000 1840	1	\$3,000.00

CHAIN LOOPS TO SUIT NON-STIHL CHAINSAWS

TYPE	PITCH	GAUGE	DRIVE LINKS	LENGTH	SPECIAL FEATURE	ORDER NUMBER	CASE QTY	RRP INC. GST
3/8 .050 PICCO MICRO SEMI CHISEL								
63PM	3/8"	.050"	52DL	40CM/16"	PICCO MICRO	3613 000 0052	20	\$39.00
63PM	3/8"	.050"	56DL	40CM/16"	PICCO MICRO	3613 000 0056	20	\$42.00
.325 .050 RAPID MICRO SEMI CHISEL								
23RM	.325"	.050"	65DL	40CM/16"	RAPID MICRO	3627 000 0065	20	\$34.00
23RM	.325"	.050"	66DL	40CM/16"	RAPID MICRO	3627 000 0066	20	\$36.00
23RM	.325"	.050"	78DL	50CM/20"	RAPID MICRO	3627 000 0078	20	\$38.00
.325 .050 RAPID DURO PRO (3) LOW KICKBACK								
23RD3 PRO	.325"	.050"	66DL	40CM/16"	RAPID DURO	3696 000 0066	20	\$123.00
23RD3 PRO	.325"	.050"	72DL	45CM/18"	RAPID DURO	3696 000 0072	20	\$134.00
.325 .058 RAPID MICRO SEMI CHISEL								
25RM	.325"	.058"	64DL	38CM/15"	RAPID MICRO	3685 000 0064	20	\$42.00
25RM	.325"	.058"	72DL	45CM/18"	RAPID MICRO	3685 000 0072	20	\$50.00
.325 .058 RAPID SUPER FULL CHISEL								
25RS	.325"	.058"	64DL	38CM/15"	RAPID SUPER	3638 000 0064	20	\$42.00
25RS	.325"	.058"	66DL	40CM/16"	RAPID SUPER	3638 000 0066	20	\$44.00
25RS	.325"	.058"	72DL	45CM/18"	RAPID SUPER	3638 000 0072	20	\$50.00

CHAIN LOOPS TO SUIT NON-STIHL CHAINSAWS

TYPE	PITCH	GAUGE	DRIVE LINKS	LENGTH	SPECIAL FEATURE	ORDER NUMBER	CASE QTY	RRP INC. GST
.325 .058 RAPID DURO (3) LOW KICK BACK								
25RD3	.325"	.058"	64DL	38CM/15"	RAPID DURO	3666 000 0064	20	\$103.00
25RD3	.325"	.058"	66DL	40CM/16"	RAPID DURO	3666 000 0066	20	\$113.00
25RD3	.325"	.058"	72DL	45CM/18"	RAPID DURO	3666 000 0072	20	\$128.00
3/8 .050 RAPID MICRO SEMI CHISEL								
33RM	3/8"	.050"	60DL	40CM/16"	RAPID MICRO	3650 000 0060	20	\$50.00
33RM	3/8"	.050"	70DL	50CM/20"	RAPID MICRO	3650 000 0070	20	\$56.00
3/8 .058 RAPID MICRO SEMI CHISEL								
35RM	3/8"	.058"	60DL	40CM/16"	RAPID MICRO	3651 000 0060	20	\$50.00
35RM	3/8"	.058"	68DL	45CM/18"	RAPID MICRO	3651 000 0068	20	\$50.00
35RM	3/8"	.058"	72DL	50CM/20"	RAPID MICRO	3651 000 0072	20	\$56.00
35RM	3/8"	.058"	75DL	56CM/22"	RAPID MICRO	3651 000 0075	20	\$56.00
35RM	3/8"	.058"	84DL	61CM/24"	RAPID MICRO	3651 000 0084	20	\$61.00
35RM	3/8"	.058"	92DL	71CM/28"	RAPID MICRO	3651 000 0092	12	\$67.00
3/8 .058 RAPID SUPER FULL CHISEL								
35RS	3/8"	.058"	60DL	40CM/16"	RAPID SUPER	3622 000 0060	20	\$50.00
35RS	3/8"	.058"	68DL	45CM/18"	RAPID SUPER	3622 000 0068	20	\$50.00
35RS	3/8"	.058"	72DL	50CM/20"	RAPID SUPER	3622 000 0072	20	\$56.00
35RS	3/8"	.058"	84DL	61CM/24"	RAPID SUPER	3622 000 0084	20	\$61.00
35RS	3/8"	.058"	92DL	71CM/28"	RAPID SUPER	3622 000 0092	12	\$67.00

CHAIN SPARES

ITEM	TYPE	PITCH	DESCRIPTION	ORDER NUMBER	MIN ORDER	RRP INC. GST
TIE STRAP KIT		1/4"	PACK OF 10	3660 660 6000	1	\$5.00
TIE STRAP KIT		1/4"P	PACK OF 11	3669 660 6000	1	\$5.00
TIE STRAP KIT		.325"	PACK OF 8	3686 660 6000	1	\$5.00
TIE STRAP KIT		.325" PRO	PACK OF 8	3690 660 6000	1	\$5.00
TIE STRAP KIT		3/8"PM	PACK OF 9	3610 660 6000	1	\$5.00
TIE STRAP KIT		3/8"P	PACK OF 9	3997 660 6020	1	\$5.00
TIE STRAP KIT		3/8"	PACK OF 9	3824 660 6020	1	\$6.00
TIE STRAP KIT		.404"	PACK OF 8	3812 660 6020	1	\$10.00
RH CUTTER	63PD3		RH TIE STRAP PACK - PACK OF 5	3612 007 1000	1	\$21.00
LH CUTTER	63PD3		LH TIE STRAP PACK - PACK OF 5	3612 007 1001	1	\$21.00

CHAIN SPARES

ITEM	TYPE	PITCH	DESCRIPTION	ORDER NUMBER	MIN ORDER	RRP INC. GST
RH CUTTER	36RD		RH TIE STRAP PACK - PACK OF 5	3943 007 1000	1	\$21.00
LH CUTTER	36RD		LH TIE STRAP PACK - PACK OF 5	3943 007 1001	1	\$21.00
RH CUTTER	36RD3		RH TIE STRAP PACK - PACK OF 5	3683 007 1000	1	\$21.00
LH CUTTER	36RD3		LH TIE STRAP PACK - PACK OF 5	3683 007 1001	1	\$21.00
RH CUTTER REPAIR KIT	63PS		PACK OF 5	3616 007 1000	1	\$17.00
LH CUTTER REPAIR KIT	63PS		PACK OF 5	3616 007 1001	1	\$17.00
RH CUTTER REPAIR KIT	36RS		PACK OF 5	3621 007 1000	1	\$8.00
LH CUTTER REPAIR KIT	36RS		PACK OF 5	3621 007 1001	1	\$8.00
RH CUTTER REPAIR KIT	40RMHS		PACK OF 5	3620 007 1000	1	\$6.00
LH CUTTER REPAIR KIT	40RMHS		PACK OF 5	3620 007 1001	1	\$6.00
RH CUTTER REPAIR KIT	26RM		PACK OF 5	3629 007 1000	1	\$6.00
LH CUTTER REPAIR KIT	26RM		PACK OF 5	3629 007 1001	1	\$6.00
RH CUTTER REPAIR KIT	63PM3		PACK OF 5	3636 007 1000	1	\$6.00
LH CUTTER REPAIR KIT	63PM3		PACK OF 5	3636 007 1001	1	\$6.00
RH CUTTER REPAIR KIT	26RD3 DURO		PACK OF 5	3667 007 1000	1	\$21.00
LH CUTTER REPAIR KIT	26RD3 DURO		PACK OF 5	3667 007 1001	1	\$21.00
RH CUTTER	RDR	RESCUE	SINGLE CUTTER	3944 660 6300	1	\$6.00
DRIVE LINK	PM + PD3	HUMPED	SINGLE CHAIN LINK	3636 662 1100	1	\$1.00
STICKER			CHAIN LINK MEASURE	5910 890 9800	1	\$16.00

GUIDE BARS (FOR DETAILS ON NEW NAMING CONVENTION SEE PG 126)

PITCH	TYPE	LENGTH	DESCRIPTION	ORDER NUMBER	MIN ORDER	CASE QTY	RRP INC. GST
1/4P .043 LIGHT							
1/4P	.043"	10CM/4"	LIGHT (GTA 26)	3007 003 0101	1	1	\$24.00
1/4.043 CARVING							
1/4"	.043"	30CM/12"	CARVING	3005 000 3105	1	50	\$148.00
1/4.050 CARVING							
1/4"	.050"	30CM/12"	CARVING	3005 000 3205	1	50	\$164.00
1/4.043 LIGHT 01 (FMR ROLLOMATIC E MINI)							
1/4"	.043"	25CM/10"	LIGHT 01	3005 008 3403	1	50	\$46.00
1/4"	.043"	30CM/12"	LIGHT 01	3005 008 3405	1	50	\$62.00
1/4"	.043"	35CM/14"	LIGHT 01	3005 008 3409	1	50	\$72.00
3/8PMM .043 LIGHT 01 (FMR ROLLOMATIC E MINI)							
3/8PMM	.043"	30CM/12"	LIGHT 01	3005 008 3905	1	50	\$62.00
3/8PMM	.043"	35CM/14"	LIGHT 01 (MINIBOSS)	3005 803 3909	1	50	\$72.00
3/8PMM	.043"	40CM/16"	LIGHT 01 (MINIBOSS)	3005 008 3913	1	50	\$77.00

FMR = Formerly

GUIDE BARS (FOR DETAILS ON NEW NAMING CONVENTION SEE PG 126)

PITCH	TYPE	LENGTH	DESCRIPTION	ORDER NUMBER	MIN ORDER	CASE QTY	RRP INC. GST
3/8PMM .043 LIGHT P01 (FMR ROLLOMATIC E MINI LIGHT)							
3/8PMM	.043"	30CM/12"	LIGHT P01	3005 000 7605	1	50	\$72.00
3/8PMM	.043"	35CM/14"	LIGHT P01	3005 000 7609	1	50	\$82.00
3/8P .043 LIGHT L04 (FMR ROLLOMATIC E)							
3/8P	.043"	30CM/12"	LIGHT 04	3005 000 4405	1	50	\$70.00
3/8P	.043"	30CM/14"	LIGHT 04	3005 000 4409	1	50	\$75.00
3/8P	.043"	30CM/16"	LIGHT 04	3005 000 4413	1	50	\$77.00
3/8P .050 LIGHT O4 (FMR ROLLOMATIC ES)							
3/8"P	.050"	40CM/16"	LIGHT 04	3005 000 4813	1	50	\$87.00
3/8"P	.050"	30CM/12"	LIGHT 04	3005 000 4805	1	50	\$72.00
3/8"P	.050"	35CM/14"	LIGHT 04	3005 000 4809	1	50	\$77.00
3/8P .050 LIGHT P04 (FMR ROLLOMATIC E LIGHT)							
3/8"P	.050"	30CM/12"	LIGHT 04	3005 000 7405	1	50	\$82.00
3/8"P	.050"	35CM/14"	LIGHT 04	3005 000 7409	1	50	\$87.00
3/8"P	.050"	40CM/16"	LIGHT 04	3005 000 7413	1	50	\$92.00
3/8P .050 LIGHT O4 (FMR ROLLOMATIC E 9T)							
3/8"P	.050"	32CM/13"	LIGHT 04	3003 000 6306	1	50	\$82.00
3/8"P	.050"	40CM/16"	LIGHT 04	3003 000 6313	1	40	\$92.00
3/8P .050 LIGHT O4 (FMR ROLLOMATIC E 10T)							
3/8"P	.050"	45CM/18"	LIGHT 04	3005 000 4817	1	40	\$92.00
.325 .050 LIGHT O4 (FMR ROLLOMATIC E)							
.325"	.050"	35CM/14"	LIGHT 04	3003 000 3309	1	50	\$80.00
.325"	.050"	40CM/16"	LIGHT 04	3003 000 3313	1	40	\$90.00
.325"	.050"	45CM/18"	LIGHT 04	3003 008 3317	1	40	\$100.00
.325"	.050"	50CM/20"	LIGHT 04	3003 008 3321	1	30	\$110.00
.325 .063 LIGHT O4 (FMR ROLLOMATIC E)							
.325"	.063"	40CM/16"	LIGHT 04 (FARMBOSS)	3005 814 4713	1	50	\$87.00
.325"	.063"	45CM/18" 68DL	LIGHT 04	3005 008 4717	1	40	\$92.00
.325"	.063"	35CM/14"	LIGHT 04	3005 000 4709	1	50	\$82.00
.325"	.063"	40CM/16"	LIGHT 04	3003 008 6813	1	40	\$82.00
.325"	.063"	45CM/18" 74DL	LIGHT 04	3003 008 6817	1	40	\$92.00
.325"	.063"	50CM/20"	LIGHT 04	3003 008 6821	1	30	\$103.00
.325.063 LIGHT O4 (FMR ROLLOMATIC E 10T)							
.325"	.063"	32CM/13"	LIGHT 04	3003 000 5306	1	50	\$82.00
3/8 .063 LIGHT O6 (FMR ROLLOMATIC E)							
3/8"	.063"	50CM/20"	LIGHT 06	3003 000 5221	1	30	\$113.00
3/8"	.063"	63CM/25"	LIGHT 06	3003 000 5231	1	25	\$128.00
3/8"	.063"	50CM/20"	LIGHT 06 (FARMBOSS)	3003 813 5221	1	30	\$103.00
3/8"	.063"	40CM/16"	LIGHT 06	3003 000 5213	1	40	\$92.00
3/8"	.063"	45CM/18"	LIGHT 06	3003 000 5217	1	40	\$103.00
3/8 .050 LIGHT O6 (FMR ROLLOMATIC E 11T)							
3/8"	.050"	63CM/25"	LIGHT 06	3003 000 7831	1	25	\$128.00

GUIDE BARS (FOR DETAILS ON NEW NAMING CONVENTION SEE PG 126)

PITCH	TYPE	LENGTH	DESCRIPTION	ORDER NUMBER	MIN ORDER	CASE QTY	RRP INC. GST
3/8 .063 STRONG X (FMR ROLLOMATIC ES)							
3/8"	.063"	50CM/20"	STRONG X	3003 000 9421	1	30	\$184.00
3/8"	.063"	55CM/22"	STRONG X	3003 000 9425	1	30	\$194.00
3/8"	.063"	63CM/25"	STRONG X	3003 000 9431	1	25	\$210.00
3/8"	.063"	75CM/30"	STRONG X	3003 000 6041	1	20	\$261.00
3/8"	.063"	90CM/36"	STRONG X	3003 000 6053	1	20	\$286.00
3/8.063 LIGHT X (FMR ROLLOMATIC ES LIGHT)							
3/8"	.063"	50CM/20"	LIGHT X	3003 000 2021	1	30	\$230.00
3/8"	.063"	63CM/25"	LIGHT X	3003 000 2031	1	25	\$250.00
3/8"	.063"	71CM/28"	LIGHT X	3003 000 2038	1	25	\$276.00
3/8"	.063"	80CM/32"	LIGHT X	3003 000 2046	1	20	\$296.00
3/8"	.063"	90CM/36"	LIGHT X	3003 000 2053	1	20	\$322.00
3/8 .063 LIGHT O6 (FMR ROLLOMATIC ES)							
3/8"	.063"	50CM/20"	STRONG X (MS 462 C-M R)	3003 002 9421	1	30	\$169.00
3/8 .063 LIGHT O4 (FMR ROLLOMATIC G)							
3/8"	.063"	40CM/16"	STRONG G (GS 461)	3006 000 1513	1	30	\$230.00
3/8 & .404 .063 STRONG S (FMR DUROMATIC E)							
3/8" & .404"	.063"	40CM/16"	STRONG S	3003 000 9213	1	40	\$128.00
3/8" & .404"	.063"	45CM/18"	STRONG S	3003 000 9217	1	30	\$138.00
3/8" & .404"	.063"	50CM/20"	STRONG S	3003 000 9221	1	30	\$148.00
3/8" & .404"	.063"	63CM/25"	STRONG S	3003 001 5631	1	25	\$148.00
.404 .063 STRONG X (FMR ROLLOMATIC ES)							
.404"	.063"	50CM/20"	STRONG X	3003 000 9721	1	30	\$194.00
.404"	.063"	63CM/25"	STRONG X	3002 000 9731	1	25	\$230.00
.404"	.063"	75CM/30"	STRONG X	3002 000 9741	1	20	\$250.00
.404"	.063"	90CM/36"	STRONG X	3002 000 9753	1	1	\$276.00
.404"	.063"	150CM/59"	STRONG X	3002 000 9576	1	1	\$689.00
3/8 .404 .063 STRONG S (FMR DUROMATIC E)							
3/8" & .404"	.063"	43CM/17"	STRONG S	3002 000 9215	1	40	\$113.00
3/8" & .404"	.063"	63CM/25"	STRONG S	3002 000 9231	1	25	\$138.00
3/8" & .404"	.063"	75CM/30"	STRONG S	3002 000 8041	1	20	\$194.00
3/8" & .404"	.063"	80CM/32"	STRONG S	3002 000 8045	1	20	\$220.00
3/8" & .404"	.063"	90CM/36"	STRONG S	3002 000 8052	1	20	\$240.00
.404 .063 STRONG S (FMR ROLLOMATIC ES)							
.404"	.063"	63CM/25"	STRONG X	3003 000 9731	1	25	\$220.00
3/8 .404 .063 STRONG S (FMR DUROMATIC E)							
3/8" & .404"	.063"	105CM/41"	STRONG S	3002 000 8058	1	10	\$261.00
3/8" & .404"	.063"	120CM/47"	STRONG S	3002 000 8064	1	1	\$444.00

SPUR SPROCKET FOR CARVING GUIDE BARS

	SUITABLE FOR	ORDER NUMBER	MIN ORDER	RRP INC. GST
1/4" 8T	MS 162 / 170 / 171 / 172 / 180 / 181 / 182 / 212 / 231 / 241 / 251	1123 640 2007	1	\$43.00

i REFER TO SSC, MS CUTTING ATTACHMENT GUIDE FOR ALL SUITABLE BAR & CHAIN APPLICATIONS



Note: New design guide bars will be released as old stock depletes
FMR = Formerly

Note: The actual bar length may be shorter than the stated bar length



SCABBARDS

	MOUNT TYPE	BAR LENGTH	ORDER NUMBER	MIN ORDER	RRP INC. GST
	3005	25CM/10" MINI	0000 792 9170	1	\$7.00
		30CM/12" MINI	0000 792 9171	1	\$7.00
		35CM/14"	0000 792 9172	1	\$7.00
		45CM/18"	0000 792 9173	1	\$7.00
	3003	45CM/18"	0000 792 9175	1	\$8.00
		55CM/21"	0000 792 9176	1	\$8.00
		63CM/25"	0000 792 9177	1	\$8.00
	3002, 3003	75CM/30"	0000 792 9178	1	\$8.00
		90CM/36"	0000 792 9179	1	\$12.00
	3005	EXTENSION 30CM/12"	0000 792 9140	1	\$8.00
TOP HANDLE 35CM/14" SUITS MS 201 T C-M		0000 792 9160	1	\$13.00	
TOP HANDLE 40CM/16" SUITS MS 201 T C-M		0000 792 9161	1	\$13.00	
3006	GS461	0000 792 9175	1	\$8.00	





FILE SYSTEMS

	PITCH (INCHES)	FILE SIZE	ORDER NUMBER	MIN ORDER	RRP INC. GST
2-IN-1 	1/4"P	3.2MM 1/8	5605 750 4306	1	\$67.00
	3/8"P	4MM 5/32	5605 750 4303	1	\$67.00
	.325"	4.8MM 3/16	5605 750 4304	1	\$67.00
	3/8"	5.2MM 13/64	5605 750 4305	1	\$67.00
	.404"	5.5MM 7/32	0000 750 4300	1	\$67.00
2-IN-1 Round & flat replacements 	1/4"P	3.2MM 1/8 ROUND	0000 893 6401	12	\$7.00 EACH
	3/8"P	4MM 5/32 ROUND	5605 772 4002	12	\$7.00 EACH
	.325"	4.8MM 3/16 ROUND	5605 772 4802	12	\$7.00 EACH
	3/8"	5.2MM 13/64 ROUND	5605 772 5202	12	\$7.00 EACH
	.404"	5.5MM 7/32 ROUND	5605 772 5502	12	\$7.00 EACH
	FLAT	-	0814 252 3001	5	\$21.00 EACH
FILE & FILE HOLDER 	1/4"P	3.2MM 1/8	5605 750 4300	1	\$29.00
	3/8"P	4MM 5/32	5605 750 4327	1	\$29.00
	.325"	4.8MM 3/16	5605 750 4328	1	\$29.00
	3/8"	5.2MM 13/64	5605 750 4329	1	\$29.00
	.404"	5.5MM 7/32	5605 750 4330	1	\$29.00





FILE GUIDES

		SUITABLE FOR:	PITCH	ORDER NUMBER	MIN ORDER	RRP INC. GST
FF1 FILE HOLDER 		1/4"P	3.2MM	5614 000 7504	1	\$27.00
		3/8"P MINI	4MM	5614 000 7503	1	\$27.00
		3/8"P	4MM	5614 000 7502	1	\$27.00
		.325"	4.8MM	5614 000 7501	1	\$27.00
		3/8"	5.2MM	5614 000 7500	1	\$27.00
		.404"	5.5MM	5614 000 7505	1	\$27.00
MAGNETIC ANGLE PLATE 				0000 750 9900	1	\$19.00





CHAIN SHARPENING

		PITCH (INCHES)	ORDER NUMBER	MIN ORDER	RRP INC. GST
FILE KITS 		1/4"P	5605 007 1000	1	\$50.00
		1/4" 3/8"P	5605 007 1027	1	\$50.00
		.325"	5605 007 1028	1	\$50.00
		3/8"	5605 007 1029	1	\$50.00
		.404"	5605 007 1030	1	\$50.00
HEXA SHARPENING KIT 		3/8	5607 007 1000	1	\$50.00
FILE GAUGES 		FL1 1/4"P	0000 893 4006	1	\$12.00
		FL2 3/8"P	0000 893 4007	1	\$12.00
		FL3 .325"	0000 893 4008	1	\$12.00
		FL4 3/8"	0000 893 4009	1	\$12.00
		FL5 .404"	0000 893 4010	1	\$12.00
FILE GAUGES For checking side & top-plate cutting angle 		1/4"P	0000 893 4005	1	\$12.00
		.404"	1106 893 4000	1	\$12.00
		1/4" 3/8"P .325" 3/8" HEXA	1110 893 4000	5	\$12.00



FILES

		PITCH (INCHES)	FILE SIZE	LENGTH	ORDER NUMBER	MIN ORDER	RRP INC. GST
FLAT				150MM	0814 252 3000	12	\$11.00
ROUND		1/4"P	3.2MM - 1/8	150MM	5605 771 3206	6	\$6.00
		1/4 - 3/8"P	4MM - 5/32	200MM	5605 773 4003	36	\$6.00
		.325"	4.8MM - 3/16	200MM	5605 773 4803	36	\$6.00
		3/8"	5.2MM - 13/64	200MM	5605 773 5203	36	\$6.00
		.404"	5.5MM - 7/32	200MM	5605 773 5503	36	\$6.00
		*	3.5MM - 9/64	150MM	5605 771 3506	6	\$6.00
		*	6.35MM - 1/4	200MM	5605 771 6306	6	\$6.00
TRIANGULAR To suit FG2 & FG3*		2/3"			0811 421 8971	1	\$14.00
HEXA		3/8"	5.2MM	200MM	5607 772 5201	1	\$15.00

FILE HANDLES

		ORDER NUMBER	RRP INC. GST			ORDER NUMBER	RRP INC. GST
PLASTIC Storage area for one spark plug in handle		0000 881 4500	\$8.00 EACH MIN ORDER: 20	WOODEN Compatible with HEXA file		0811 490 7860	\$5.00 EACH MIN ORDER: 20
2 PIECE		0000 881 4502	\$11.00 EACH MIN ORDER: 10	PLASTIC Compatible with HEXA file		0000 881 4504	\$8.00 EACH MIN ORDER: 18

12V SHARPENERS

		RPM	ORDER NUMBER	MIN ORDER	RRP INC. GST
QUICKSHARP		14,000	7004 871 0139	1	\$75.00
SUPERSHARP		24,000	7004 871 0140	1	\$96.00

*Chain no longer produced by STIHL



FILE STONES & ACCESSORIES

	PITCH	STONE DIAMETER	ORDER NUMBER	MIN ORDER	RRP INC. GST
QUICKSHARP & SUPERSHARP REPLACEMENT GRINDING STONES 	1/4"P	3.2MM	7004 882 4100	5	\$6.50 EACH
	3/8"P	4MM	7004 871 0141	5	\$6.50 EACH
	.325"	4.8MM	7004 871 0142	5	\$6.50 EACH
	3/8"	5.2MM	7004 871 0216	5	\$6.50 EACH
	.404"	5.5MM	7004 871 0143	5	\$6.50 EACH
	1/4"	6.3MM	7004 871 0144	5	\$6.50 EACH



FILE STONE ACCESSORY

	SUITABLE FOR:	ORDER NUMBER	MIN ORDER	RRP INC. GST
COOLING & LUBRICANT 	QUICKSHARP & SUPERSHARP	0787 940 1751	1	\$7.00

STUMP VICES

	SIZE	ORDER NUMBER	MIN ORDER	RRP INC. GST
S260 	SMALL	0000 881 0402	1	\$42.00
L700 	LARGE	0000 881 0403	1	\$62.00

GUIDE BAR MAINTENANCE

	ORDER NUMBER	MIN ORDER	RRP INC. GST
GUIDE BAR DRESSER 	5605 773 4400	1	\$61.00
REPLACEMENT FILE - GUIDE BAR DRESSER 	5605 773 4200	1	\$25.00
SHARPENING STONE 	5203 893 6200	1	\$11.00

ELECTRIC GRINDER

USG KIT

INCLUDES GRINDING WHEELS:
1 X 5203 750 7013 & 1 X 5203 750 7015



ORDER NUMBER	MIN ORDER	RRP INC. GST
--------------	-----------	--------------

5203 200 0008 1 \$1,240.00





ELECTRIC GRINDER ACCESSORIES

	SUITABLE FOR:	ORDER NUMBER	MIN ORDER	RRP INC. GST
SWIVELLING CLAMP SYSTEMS	HEDGE TRIMMER BLADE	5203 750 1400	1	\$698.00
	FS CIRCULAR SAW BLADE	5203 750 2800	1	\$378.00
	MS SAW CHAIN	5203 750 1410	1	\$331.00
CLAMP	CHAINSAW ATTACHMENT - FOOT OPERATED	5203 007 1003	1	\$175.00
DRESSING KIT	DIAMOND WHEELS	5203 890 4400	1	\$513.00
GRINDING WHEELS	1/4" 3/8"P .325" - CHAIN	5203 750 7013	1	\$30.00
	.325" 3/8" .404" - CHAIN	5203 750 7010	1	\$30.00
	1/4" PICCO MICRO 3	5203 750 7017	1	\$30.00
	3/8" .404" - CHAIN & HEDGE TRIMMER BLADE	5202 750 7010	1	\$30.00
	HEXA Chain 3/8	5203 750 7018	1	\$40.00
DIAMOND GRINDING WHEELS FOR DURO CHAIN	3/8" PD3, .325" RD3 AND 3/8"RD3 CHAIN	5203 757 0906	1	\$497.00
	3/8" PD3, .325" RD3 CHAIN (22.2mm other grinding machines)	5203 757 0908	1	\$498.00
DRESSING GAUGE	USG GRINDING WHEELS (INC HEXA)	5203 893 6308	1	\$9.00
HANDLE KIT	USG REPLACEMENT HANDLE	5203 007 1006	1	\$48.00
DEPTH GAUGE	.325" 3/8" .404" - CHAIN	5202 750 7000	1	\$48.00
	1/4" 3/8"P .325" .404" - CHAIN	5203 750 7015	1	\$36.00







CHAIN BREAKERS & RIVET SPINNERS

	ORDER NUMBER	RRP INC. GST		ORDER NUMBER	RRP INC. GST
CHAIN BREAKER NG4	5805 012 7500	\$449.00 MIN ORDER: 1		CHAIN BREAKER & RIVET SPINNER NG7	5805 012 7520 \$862.00 MIN ORDER: 1
CHAIN RIVET SPINNER NG5	5805 012 7510	\$529.00 MIN ORDER: 1		CHAIN LINK MEASURE (STICKER)	5910 890 9800 \$41.00 MIN ORDER: 1

CHAINSAW ACCESSORIES

		DESCRIPTION	ORDER NUMBER	MIN ORDER	RRP INC. GST
CHAINSAW CASE 		FITS UP TO MS 391 & MSA 300 C-O EXCLUDING MS 381 INCLUDES SCABBARD	0000 900 4008	4	\$103.00
		MEDIUM FITS MS 170 TO MS 500i EXCLUDES SCABBARD	0000 900 4011	1	\$121.00
		LARGE FITS UP TO MS 881 C-M EXCLUDES SCABBARD	0000 900 4010	1	\$143.00
PLASTIC LATCH (Spare for chainsaw case) 			7010 881 5600	1	\$6.00
MULTI TOOL Spark plug & bar nut 		SOCKET SIZES 13 & 19MM	0000 881 5501	1	\$72.00
		SOCKET SIZES 16 & 19MM	0000 881 5502	1	\$72.00
STORAGE BOX 		CHAIN LOOP & SPARK PLUG HOLDER	0000 882 5900	1	\$12.00
SAWHORSE Wooden (Assembly required) 			0000 881 4602	1	\$133.00



POLE PRUNER ACCESSORIES

	ORDER NUMBER	RRP INC. GST		ORDER NUMBER	RRP INC. GST
RTS HARNESS HT 75/103/105 / 133/135/HTA 85 / 135 (Shaft clamp not supplied) 	0000 790 4400	\$347.00 MIN ORDER: 1	ANGLED GEARHEAD ROUND SHAFT HT 56 / HT 75/101/ HT-KM/HTE 60 / HT 131 	4138 640 0201	\$301.00 MIN ORDER: 1
TELESCOPIC SHAFT CLAMP HT 75/103/105 / 133/135/HTA 85 / 135/HLA 85 	0000 790 8600	\$31.00 MIN ORDER: 1	ANGLED GEARHEAD SQUARE SHAFT HT 103 / 133 / HTA 135 	4182 640 0200	\$327.00 MIN ORDER: 1
FOOT HTA 65/66 / HTA 85/86 / HLA 65/85 	4857 007 1001	\$56.00 MIN ORDER: 1	HTA 50 EXTENSION SHAFT 50CM 	LA02 820 5000	\$65.00 MIN ORDER: 1

FORESTRY ACCESSORIES - MEASURING & MARKING

		DESCRIPTION	ORDER NUMBER	MIN ORDER	RRP INC. GST
LOGGERS TAPE METAL		25M	0000 881 0801	1	\$179.00
		REFILL - 25M	0000 881 0872	1	\$92.00



WEDGES

		SIZE	ORDER NUMBER	MIN ORDER	RRP INC. GST
ALLOY WEDGES		XS - 190G/12CM	0000 881 2201	1	\$25.00
		S - 600G/22CM	0000 881 2222	1	\$67.00
		M - 800G/24CM	0000 881 2223	1	\$92.00
		L - 1000G/26CM	0000 881 2224	1	\$113.00
		ROTATING - 920G	0000 881 2221	1	\$103.00
		TWIST ACTION SPLITTING WEDGE	0000 881 2219	1	\$87.00
PLASTIC WEDGES		200MM - WHITE	7004 871 0152	1	\$14.00
		NEW - 190MM - ORANGE	0000 881 2212	1	\$16.00
		NEW - 230MM - ORANGE	0000 881 2213	1	\$23.00
		NEW - 250MM - ORANGE	0000 881 2214	1	\$26.00

CHAINSAW CLEANING AND MAINTENANCE

		DESCRIPTION	ORDER NUMBER	MIN ORDER	RRP INC. GST
MS CARE AND CLEAN KIT		MS CARE AND CLEAN KIT	0782 516 8609	1	\$56.00



ELECTRIC GRASS TRIMMERS FOR HOME USE

		POWER OUTPUT WATTS (W)	WEIGHT (KG)	ORDER NUMBER	MIN ORDER	RRP INC. GST
FSE 52 AUTOCUT 2-2		500	2.2	4816 011 4102	1	\$179.00
FSE 71 AUTOCUT C 5-2		540	4.0	4809 011 4107	1	\$199.00

PETROL GRASS TRIMMERS FOR HOME USE

		DISPLACEMENT (CM ³)	POWER OUTPUT (KW/HP)	WEIGHT (KG)	ORDER NUMBER	MIN ORDER	RRP INC. GST
FS 38 AUTOCUT C 6-2		27.2	0.65/0.9	4.1 [^]	4140 012 2365	2	\$279.00

PETROL BRUSHCUTTERS FOR HOME USE

		DISPLACEMENT (CM ³)	POWER OUTPUT (KW/HP)	WEIGHT (KG)	ORDER NUMBER	MIN ORDER	RRP INC. GST
FS 55 RC-E AUTOCUT C 26-2		27.2	0.75/1.0	4.9 [^]	4140 200 0595	2	\$499.00
FS 55 C-E AUTOCUT C 26-2		27.2	0.75/1.0	5.2 [^]	4140 200 0597	2	\$549.00



*WEIGHT EXCLUDING FUEL, CUTTING TOOL & GUARD

PETROL BRUSHCUTTERS FOR LONG GRASS & LANDSCAPE MAINTENANCE







		DISPLACEMENT (CM ³)	POWER OUTPUT (KW/HP)	WEIGHT (KG)	ORDER NUMBER	MIN ORDER	RRP INC. GST
FS 70 R AUTOCUT C 26-2		27.2	0.90/1.2	4.7 [^]	4144 200 0229	2	\$599.00
FS 91 R AUTOCUT C 26-2 4-MIX[®]		28.4	0.95/1.3	5.5 [^]	4180 200 0728	2	\$699.00
FS 91 AUTOCUT C 26-2 4-MIX[®]		28.4	0.95/1.3	5.8 [^]	4180 200 0729	2	\$749.00
FS 94 RC-E AUTOCUT C 26-2		24.1	0.90/1.2	4.6 [^]	4149 200 0120	2	\$749.00
FS 94 C-E AUTOCUT C 26-2		24.1	0.90/1.2	4.9 [^]	4149 200 0121	2	\$799.00
FS 111 R AUTOCUT C 26-2 4-MIX[®]		31.4	1.05/1.4	5.5 [^]	4180 200 0709	2	\$849.00
FS 111 AUTOCUT C 26-2 4-MIX[®]		31.4	1.05/1.4	5.8 [^]	4180 200 0708	2	\$899.00
FS 131 R AUTOCUT C 26-2 4-MIX[®]		36.3	1.4/1.9	5.5 [^]	4180 200 0730	2	\$949.00
FS 131 AUTOCUT C 26-2 4-MIX[®]		36.3	1.4/1.9	5.8 [^]	4180 200 0731	2	\$999.00
FS 240 R AUTOCUT 36-2		37.7	1.7/2.3	6.6 [^]	4147 200 0451	2	\$1,149.00
FS 240 AUTOCUT 36-2		37.7	1.7/2.3	7.0 [^]	4147 200 0473	2	\$1,199.00
FS 261 C-E BRUSH KNIFE 300-3		41.6	2.0/2.7	7.9 [^]	4147 200 0601	1	\$1,399.00

[^]WEIGHT EXCLUDING FUEL, CUTTING TOOL & GUARD

PETROL BRUSHCUTTERS FOR LONG GRASS & LANDSCAPE MAINTENANCE

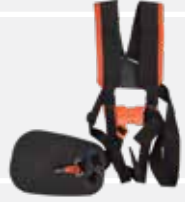



	DISPLACEMENT (CM ³)	POWER OUTPUT (KW/HP)	WEIGHT (KG)	ORDER NUMBER	MIN ORDER	RRP INC. GST
FS 361 C-EM BRUSH KNIFE 300-3 	37.7	1.7 / 2.3	8.6 [^]	4147 200 0614	1	\$1,799.00
FS 461 C-EM L BRUSH KNIFE 300-3 	45.6	2.2 / 3.0	8.7 [^]	4147 200 0654	1	\$1,999.00
FS 561 C-EM SAW BLADE 225-36 	57.1	2.8 / 3.8	10.2 [^]	4148 200 0229	1	\$2,899.00

HARNESES



		ORDER NUMBER	MIN ORDER	RRP INC. GST	
SHOULDER LOOP		4119 710 9012	1	\$15.00	
PADDED LOOP		4852 007 1000	1	\$35.00	
DOUBLE SHOULDER		4119 710 9001	1	\$75.00	
ADVANCE UNIVERSAL		STANDARD SIZE	4147 710 9002	1	\$160.00
		XXL SIZE	4147 710 9004	1	\$160.00
ADVANCE PLUS		4147 710 9014	1	\$170.00	
ADVANCE FORESTRY		STANDARD SIZE	4147 710 9003	1	\$200.00
		XXL SIZE	4147 710 9009	1	\$200.00

[^]WEIGHT EXCLUDING FUEL, CUTTING TOOL & GUARD





HARNESSES

		ORDER NUMBER	MIN ORDER	RRP INC. GST
ADVANCE X-TREEm HARNESSES		To suit: FS 91 - FS 561 FSA 90 - FSA 200	0000 710 9001	1 \$320.00
TOOL BACKPACK			4147 881 5700	1 \$85.00
CHEST STRAP For compatible machines refer to SSC			0000 790 7700	1 \$25.00
HAND GUARD KIT		To suit: FS 240 / 260 / 261 / 360 / 361 / 460 / 461 / 560 / 561 When shredding & clearing heavy material (Not suitable for FS 261.1, FS 361.1, FS 461.1 and FS 561.1)	4147 790 9102	1 \$36.00
NEW HAND GUARD KIT		To suit: FS 261.1, / 361.1, / 461.1 / 561.1 When shredding & clearing heavy material (With white coloured hand grips)	4147 790 9103	1 \$69.00

NYLON LINES - SQUARE

		SIZE	ORDER NUMBER	CASE QTY	RRP INC. GST
ORANGE		2.4MM X 253M	0000 930 2612	9	\$61.00
		2.4MM X 420M	0000 930 2613	8	\$77.00
RED		2.7MM X 208M	0000 930 2616	9	\$61.00
		2.7MM X 347M	0000 930 2617	8	\$77.00
BLACK		3.3MM X 137M	0000 930 2622	9	\$61.00
		3.3MM X 228M	0000 930 2623	8	\$77.00



NYLON LINES - ROUND

		SIZE	ORDER NUMBER	CASE QTY	MIN ORDER	RRP INC. GST
BLUE		1.6MM X 19M	0000 930 2334	24	1	\$10.00
GREEN		2.0MM X 14M	0000 930 2335	24	24	\$10.00 EACH
		2.0MM X 60M	0000 930 2336	10	1	\$19.00
		2.0MM X 119M	0000 930 2337	10	1	\$31.00
ORANGE		2.4MM X 14M	0000 930 2338	24	24	\$10.00 EACH
		2.4MM X 41M	0000 930 2339	10	1	\$19.00
		2.4MM X 83M	0000 930 2340	10	1	\$31.00
		2.4MM X 253M	0000 930 2246	9	1	\$61.00
		2.4MM X 420M	0000 930 2247	8	1	\$77.00
RED		2.7MM X 9M	0000 930 2341	24	1	\$10.00
		2.7MM X 32M	0000 930 2342	10	1	\$19.00
		2.7MM X 65M	0000 930 2343	10	1	\$31.00
		2.7MM X 208M	0000 930 2227	9	1	\$61.00
		2.7MM X 347M	0000 930 2289	8	1	\$77.00
YELLOW		3.0MM X 162M	0000 930 2542	9	1	\$59.00
		3.0MM X 271M	0000 930 2543	8	1	\$85.00
BLACK		3.3MM X 19M	0000 930 2346	10	1	\$19.00
		3.3MM X 38M	0000 930 2347	10	1	\$31.00
		3.3MM X 137M	0000 930 2287	9	1	\$61.00
		3.3MM X 228M	0000 930 2290	8	1	\$77.00
DARK GREEN		4.0MM X 27M	0000 930 3607	10	1	\$36.00
		4.0MM X 87M	0000 930 3603	9	1	\$58.00

NYLON LINES - X-LINE

		SIZE	ORDER NUMBER	CASE QTY	RRP INC. GST
GREEN		2.4MM X 83M	0000 930 3410	10	\$31.00
		2.4MM X 281M	0000 930 3401	9	\$61.00
		2.4MM X 475M	0000 930 3402	8	\$77.00
		2.7MM X 65M	0000 930 3411	10	\$31.00
		2.7MM X 205M	0000 930 3404	9	\$61.00
		2.7MM X 349M	0000 930 3405	8	\$77.00

NYLON LINES - QUIET

		SIZE	ORDER NUMBER	CASE QTY	RRP INC. GST
GREEN		2.0MM X 14M	0000 930 2416	24	\$10.00
ORANGE		2.4MM X 14M	0000 930 2419	24	\$10.00

PRE-CUT

		DESCRIPTION	ORDER NUMBER	CASE QTY	RRP INC. GST
ROUND		3.3MM - 50PK BLACK	0000 930 2316	24	\$12.00
		3.3MM - 100PK BLACK	0000 930 2318	12	\$21.00
		3.3MM - 245PK BLACK	0000 930 3608	1	\$82.00

GRASS TRIMMER, BRUSHCUTTER & CLEARING SAW ACCESSORIES

CF3 PRO
Carbon



SIZE	ORDER NUMBER	CASE QTY	RRP INC. GST
2.0MM X 45M	0000 930 4318	10	\$24.00
2.0MM X 91M	0000 930 4319	10	\$36.00
2.4MM X 35M	0000 930 4300	10	\$24.00
2.4MM X 70M	0000 930 4303	10	\$36.00
2.4MM X 212M	0000 930 4313	9	\$87.00
2.4MM X 345M	0000 930 4320	8	\$125.00
2.7MM X 26M	0000 930 4301	10	\$24.00
2.7MM X 53M	0000 930 4304	10	\$36.00
2.7MM X 172M	0000 930 4314	9	\$87.00
2.7MM X 280M	0000 930 4321	8	\$129.00
3.0MM X 21M	0000 930 4302	10	\$24.00
3.0MM X 43M	0000 930 4305	10	\$36.00
3.0MM X 134M	0000 930 4315	9	\$87.00
3.0MM X 215M	0000 930 4322	8	\$119.00
3.3MM X 113M	0000 930 4316	9	\$87.00

NYLON LINE CUTTER

NYLON LINE CUTTER



SIZE	ORDER NUMBER	MIN ORDER	RRP INC. GST
1 BOX	0000 881 8204	150	\$4.00 EACH

NYLON LINE HEADS

AUTOCUT
Bump feed



SUPERCUT
Auto feed







POLYMATIC
Manual feed



DESCRIPTION	ORDER NUMBER	CASE QTY	MIN ORDER	RRP INC. GST
2-2	4008 710 2100	10	1	\$39.00
C 3-2	4009 710 2100	10	1	\$45.00
C 4-2	4006 710 2121	10	1	\$29.00
C 6-2	4006 710 2126	8	1	\$45.00
C 12-2	4010 710 2100	8	1	\$59.00
C 26-2	4002 710 2169	8	1	\$45.00
36-2	4002 710 2170	8	1	\$59.00
46-2	4003 710 2115	8	1	\$69.00
11-2	4004 710 2192	10	1	\$31.00
27-2	4002 820 2302	8	1	\$36.00
27-2 HD	4002 820 2304	8	1	\$55.00
20-2	4002 710 2162	8	1	\$55.00
40-2	4003 710 2140	10	1	\$75.00
30-2	4002 710 2124	50	1	\$36.00

i SEE PAGES 60-64 FOR MACHINE SUITABILITY & RECOMMENDED USAGE

MOWING HEADS

	SIZE	ORDER NUMBER	CASE QTY	MIN ORDER	RRP INC. GST
TRIMCUT Manual feed 	C 32-2	4002 710 2198	—	1	\$39.00
	C 42-2 M12 X1.5MM	4003 710 2122	8	1	\$65.00
	C 52-2 M14X 1.5MM	4005 710 2117	8	1	\$69.00
POLYCUT Replaceable Nylon Blades for long grass cutting 	2-2 (FOR FSA 45)	4008 710 2102	10	1	\$31.00
	3-2 (FOR FSA 57)	4009 710 2104	10	1	\$49.00
	6-2 (FSA 60 R & FSA 86 R)	4006 710 2137	8	1	\$49.00
	12-2 (FOR FSA 70/FSA 110)	4010 710 2110	8	1	\$59.00
	18-2 (REFER SSC)	4002 820 2320	8	1	\$66.00
	28-2 (REFER SSC)	4002 820 2300	8	1	\$59.00
GREEN BLADE (12 x Pack)		4002 007 1020	12	1	\$12.00
	ORANGE BLADE (12 x Pack)	4002 007 1000	12	1	\$12.00
FIXCUT Single Strand Nylon Line Suits 2.4 - 3.3 mm line 	31-2 ALLOY	4001 710 2105	8	1	\$35.00
	5-2	4006 710 2131	8	1	\$49.00
DUROCUT Replaceable 2 or 4 Nylon Lines 	20-2	4002 710 2182	8	1	\$59.00
	40-4	4005 710 2114	8	1	\$69.00
	5-2/40-2 - 2MM X 195MM - L - 48PK	0000 930 3503	20	1	\$16.00
	5-2/40-2 - 3MM X 185MM - XL - 48PK	0000 930 3504	20	1	\$16.00
	5-2/40-2 - 4MM X 215MM - XXL - 48PK	0000 930 3505	20	1	\$16.00
	WEAR PLATE - 20-2/40-4	4005 007 1002	—	1	\$21.00

BRUSHCUTTER UPGRADE KIT

	SIZE	ORDER NUMBER	MIN ORDER	RRP INC. GST
GRASSCUT Suitable for FSA 130, 135, 200, 200 R and FS 91, 94, 111, 131, 120, 240, 260 R. Includes all necessary attachments and transport protection. NOTE - Limit Stop must be purchased separately. Refer to SSC for correct selection 	250-32	4001 007 1003	1	\$100.00

METAL BLADES

	SIZE	ORDER NUMBER	MIN ORDER	RRP INC. GST
GRASS BLADE For cutting various grass types (Ensure the correct guard is fitted. Refer to SSC) 	230-2 / ID 25.4MM	4001 713 3805	1	\$31.00
	260-2 / ID 25.4MM	4001 713 3812	1	\$50.00
	230-4 / ID 25.4MM	4001 713 3801	1	\$19.00
	230-4 / ID 20.0MM	4000 713 3801	1	\$36.00
	230-8 / ID 25.4MM	4001 713 3803	1	\$24.00
	255-8 / ID 20.0MM	4000 713 3802	1	\$42.00
	250-40 / ID 25.4MM - TUNGSTEN	4001 713 3806	1	\$67.00
	250-40 / ID 20.0MM - TUNGSTEN	4000 713 3806	1	\$61.00
BRUSH KNIFE Heavy-duty grass cutting 	250-3 / ID 25.4MM	4112 713 4100	1	\$82.00
	300-3 / ID 20.0MM	4119 713 4100	1	\$92.00
	350-3 / ID 20.0MM	4110 713 4100	1	\$103.00
	350-3 "SPECIAL" / ID 20.0MM VERY DURABLE, LONG SERVICE LIFE	4000 713 4100	1	\$128.00

i SEE PAGES 60-64 FOR MACHINE SUITABILITY & RECOMMENDED USAGE

METAL BLADES

		SIZE	ORDER NUMBER	MIN ORDER	RRP INC. GST
SCRATCHER BLADE Cutting light scrub		200-80 / ID 25.4MM	4112 713 4201	1	\$31.00
CHISEL BLADE Cutting thick scrub		225-24 / ID 20.0MM	4110 713 4204	1	\$31.00
		200-24 / ID 25.4MM	4112 713 4203	1	\$24.00
SAW SET		FOR CHISEL-TOOTH CIRCULAR SAW BLADES	4020 893 5000	1	\$25.00
CIRCULAR SAW BLADE Chisel-tooth		200 MM (22 Z) - ID 20MM	4119 713 4200	1	\$24.00
		225 MM (24 Z) - ID 20MM	4000 713 4201	1	\$23.00
SHARPENING TEMPLATE TOOL		FOR SHARPENING TRIPLE BLADED BRUSH KNIVES	4020 890 5500	1	\$14.00
HIGH PERFORMANCE SAW BLADE Cutting thick scrub. 20% more cutting performance		200-22 / ID 25.4MM	4001 713 4203	1	\$92.00
		200-22 / ID 20.0MM	4000 713 4203	1	\$103.00
		225-22 / ID 20.0MM	4000 713 4202	1	\$103.00
CARBIDE SAW BLADE Cutting thick scrub in dry conditions		225-36 / ID 20.0MM	4000 713 4211	1	\$56.00
SHREDDER BLADE For blackberries etc.		270-2 / ID 20.0MM	4000 713 3903	1	\$87.00
		320-2 / ID 20.0MM	4000 713 3902	1	\$103.00
FILE HOLDER CIRCULAR SAW BLADE		FOR CHISEL-TOOTH CIRCULAR SAW BLADES	5605 750 4343	1	\$29.00

i ENSURE CORRECT GUARD IS FITTED, REFER TO SSC

POLYCUT MOWING BLADES

		SUITABLE FOR:	ORDER NUMBER	MIN ORDER	RRP INC. GST
POLYCUT BLADES		POLYCUT 2-2, 3-2 - 8PCS	4008 007 1000	1	\$8.00
		POLYCUT 6-2, 18-2 GREEN (130MM) - 12PCS	4002 007 1020	1	\$12.00
		POLYCUT BLADES 6-2, 48-2 ORANGE (145MM) - 12 PCS	4002 007 1000	1	\$12.00
		BLADES TO SUIT POLYCUT WHITE 5-3/6-2/6-3/7-3/20-3/28-2/40-3/41-3 - 12PCS	4111 007 1001	1	\$10.00

REPLACEMENT SPOOLS

		SUITABLE FOR:	ORDER NUMBER	MIN ORDER	RRP INC. GST
MOWING HEAD*		AUTOCUT C 3-2 1.6MM	4009 710 4304	10	\$19.00
		AUTOCUT C 3-2 2.0MM	4009 710 4305	10	\$19.00
		AUTOCUT C 5-2 & 11-2	4004 710 4304	28	\$19.00
		AUTOCUT C 25-2	4002 710 4301	20	\$19.00
		AUTOCUT C 26-2	4002 740 6900	10	\$25.00
		AUTOCUT 27-2	4002 710 4320	1	\$14.00
		AUTOCUT 27-2 HEAVY DUTY	4002 710 4321	1	\$25.00
		AUTOCUT 30-2 & 40-2	4003 710 4303	10	\$45.00
		AUTOCUT 40-4	4003 710 4305	10	\$45.00
		SUPERCUT 20-2	4002 710 4309	1	\$19.00
		FSE 41	6235 710 4305	10	\$19.00
		AUTOCUT 2-2, 0.065 (FSE 52, FSA 56)	4008 710 4300	10	\$19.00
		AUTOCUT 2-2, 0.080 (FSE 52, FSA 56)	4008 710 4301	10	\$19.00
DEFLECTOR KIT		POLYCUT 28-2 AND POLYCUT 48-2	4003 007 1001	10	\$19.00

i SEE PAGES 60-64 FOR MACHINE SUITABILITY & RECOMMENDED USAGE

* SPOOL - REFER TO SSC FOR ADDITIONAL CUTTING ATTACHMENT REPLACEMENT PARTS

	Order number	Displacement (cm ³)	Power output (kW/hp)	Rated voltage (V)	Power consumption (W)	Weight (kg)	Sound pressure level ^① (dB(A))	Sound power level ^① (dB(A))	Vibration level, left/right ^② (m/s ²)	STIHL engine (2-MIX/4-MIX)	Total length without cutting tool (cm)
PETROL BRUSHCUTTERS FOR TRIMMING GRASS											
FS 38	4140 012 2365	272	0.65/0.9	-	-	4.1 [®]	94	108	8.0/8.0	-	147
FS 55 RC-E	4140 200 0595	272	0.75/1.0	-	-	5 [®]	95	108	8.5/8.5	-	170
FS 55 C-E	4140 200 0597	272	0.75/1.0	-	-	5.2 [®]	95	108	5.5/5.5	-	172
PETROL BRUSHCUTTERS FOR MOWING AROUND THE HOME & GARDEN											
FS 70 R	4144 200 0229	272	0.90/1.2	-	-	4.7 [®]	94	107	7.6/6.0	2-MIX	170
PETROL BRUSHCUTTERS FOR LONG GRASS & LANDSCAPE MAINTENANCE											
FS 91 R	4180 200 0728	28.4	0.95/1.3	-	-	5.5 [®]	95	106	5.3/5.3	4-MIX	180
FS 91	4180 200 0729	28.4	0.95/1.3	-	-	5.8 [®]	95	106	3.4/3.0	4-MIX	180
FS 94 RC-E	4149 200 0120	24.1	0.90/1.2	-	-	4.6 [®]	94	108	6.1/6.1	2-MIX	178
FS 94 C-E	4149 200 0121	24.1	0.90/1.2	-	-	4.9 [®]	94	108	4.7/4.0	2-MIX	178
FS 111 R	4180 200 0709	31.4	1.05/1.4	-	-	5.5 [®]	95	108	6.6/6.1	4-MIX	180
FS 111	4180 200 0708	31.4	1.05/1.4	-	-	5.8 [®]	95	108	5.3/4.2	4-MIX	180
FS 131 R	4180 200 0730	36.3	1.4/1.9	-	-	5.5 [®]	98	109	6.2/6.2	4-MIX	180
FS 131	4180 200 0731	36.3	1.4/1.9	-	-	5.8 [®]	98	109	4.9/4.9	4-MIX	180
FS 240 R	4147 200 0451	37.7	1.7/2.3	-	-	6.6 [®]	99	110	5.3/6.5	2-MIX	187
FS 240	4147 200 0473	37.7	1.7/2.3	-	-	7.0 [®]	100	111	5.2/4.9	2-MIX	181
FS 261 C-E	4147 200 0601	41.6	2.0/2.7	-	-	7.9 [®]	101	112	5.8/5.7	2-MIX	168
PETROL CLEARING SAWS											
FS 361 C-EM	4147 200 0614	37.7	1.7/2.3	-	-	8.5 [®]	98	110	2.2/2.0	2-MIX	179
FS 461 C-EM	4147 200 0654	45.6	2.2/3.0	-	-	8.5 [®]	100	110	1.9/1.6	2-MIX	179
FS 561 C-EM	4148 200 0229	57.1	2.8/3.8	-	-	10.2 [®]	104	117	3.3/3.3	2-MIX	176
BATTERY BRUSHCUTTERS											
FSA 30	FA10 011 5700	-	-	10.8	-	2.1 [®]	76	89	1.5/1.9	-	116
NEW FSA 50 R^④	FA11 011 5700	-	-	3.6	-	2.9 [®]	69	82	0.9/1.6	-	147
FSA 57^③	4522 011 5730	-	-	3.6	-	2.6 [®]	74	89	4.0/4.0	-	169
FSA 70 R	FA07 011 5700	-	-	3.6	-	3.5 [®]	76	91	4.9/2.0	-	166
FSA 80 R^④	FA08 011 5720	-	-	3.6	-	4.8 [®]	81	94	5.2/2.9	-	178
FSA 110 R	FA07 011 5720	-	-	3.6	-	3.6 [®]	76	91	4.9/2.0	-	171
FSA 120 R^④	FA08 200 0005	-	-	3.6	-	4.3 [®]	81	94	2.6/2.3	-	179
FSA 120^④	FA08 200 0002	-	-	3.6	-	4.5 [®]	81	94	5.8/2.8	-	179
FSA 135 R^④	FA01 200 0029	-	-	3.6	-	4.6 [®]	80	92	3.7/1.8	-	183
FSA 135^④	FA01 200 0025	-	-	3.6	-	4.9 [®]	80	92	2.9/2.0	-	183
FSA 200 R^④	FA03 200 0007	-	-	3.6	-	4.8 [®]	85	106	2.2/1.8	-	181
FSA 200^④	FA03 200 0000	-	-	3.6	-	5.7 [®]	85	106	2.2/1.8	-	181
FSA 400^④	FA09 200 0014	-	-	3.6	-	7.0 [®]	83	96	2.4/1.6	-	179
ELECTRIC BRUSHCUTTERS											
FSE 52	4816 011 4102	-	-	240	500	2.2 [®]	82	94	3.0/4.5	-	131
FSE 71	4809 011 4107	-	-	240	540	4.0 [®]	82	93	3.3/2.9	-	153

● AS STANDARD
○ RETROFITTABLE (ACCESSORY)

E = EASY2START
M = M-TRONIC
R = LOOP HANDLE

① K FACTOR ACCORDING TO DIR. 2006/42/EC = 2.5 dB(A) WITH STANDARD TOOL
② K FACTOR ACCORDING TO DIR. 2006/42/EC = 2 M/S² WITH STANDARD TOOL
③ FIXED ENGINE SPEED

④ INFINITELY VARIABLE ENGINE SPEED
⑤ WEIGHT EXCLUDING FUEL, CUTTING TOOL & GUARD
⑥ WEIGHT INCLUDING BATTERY

Standard cutting tool	Drive shaft in shaft	STIHL anti-vibration system	STIHL ElastoStart	STIHL Easy2Start (E)	STIHL M-Tronic (M)	Automatic decompression	Multi-function handle	Loop handle/bike handle/round handle	Tool-free handle adjustment	Harness / carrying system	Mowing / shredding / sawing jobs
Mowing head AutoCut C 6-2	FLEXIBLE	-	○	○	-	-	●	-/-/●	-	○	●/-/-
Mowing head AutoCut C 26-2	FLEXIBLE	-	-	●	-	-	●	●/-/-	-	●	●/-/-
Mowing head AutoCut C 26-2	FLEXIBLE	-	-	●	-	-	●	-/●/-	-	●	●/-/-
Mowing head Autocut C 26-2	FLEXIBLE	-	○	○	-	-	●	●/-/-	-	●	●/-/-
Mowing head AutoCut C 26-2	SOLID	1-point	-	-	-	●	●	●/-/-	-	●	●/-/○
Mowing head AutoCut C 26-2	SOLID	1-point	-	-	-	●	●	-/●/-	●	●	●/-/○
Mowing head AutoCut C 26-2	SOLID	1-point	-	●	-	-	●	●/-/-	-	●	●/-/-
Mowing head AutoCut C 26-2	SOLID	1-point	-	●	-	-	●	-/●/-	-	●	●/-/-
Mowing head AutoCut C 26-2	SOLID	1-point	-	-	-	●	●	●/-/-	-	●	●/-/○
Mowing head AutoCut C 26-2	SOLID	1-point	-	-	-	●	●	-/●/-	●	●	●/-/○
Mowing head AutoCut C 26-2	SOLID	1-point	-	-	-	●	●	●/-/-	-	●	●/-/○
Mowing head AutoCut C 26-2	SOLID	1-point	-	-	-	●	●	-/●/-	●	●	●/-/○
Mowing head AutoCut 36-2	SOLID	1-point	-	-	-	-	●	●/-/-	-	●	●/-/○
Mowing head AutoCut 36-2	SOLID	1-point	-	-	-	-	●	-/●/-	●	●	●/-/○
Brush Knife 300-3	SOLID	1-point	-	●	-	-	●	-/●/-	●	●	●/○/○
Brush knife 300-3	SOLID	4-point	-	●	●	-	●	-/●/-	●	●	●/○/○
Brush knife 300-3	SOLID	4-point	-	●	●	-	●	-/●/-	●	●	●/○/○
Circular saw blade 225-36	SOLID	4-point	-	●	●	-	●	-/●/-	●	●	○/○/●
Mowing head PolyCut 3-2	-	-	-	-	-	-	●	-/-/●	●	-	●/-/-
Mowing head AutoCut C 3-2	-	-	-	-	-	-	●	-/-/●	●	○	●/-/-
Mowing head AutoCut C 3-2	-	-	-	-	-	-	●	-/-/●	●	○	●/-/-
Mowing head AutoCut C12-2	-	-	-	-	-	-	●	●/-/-	●	-	●/-/-
Mowing head AutoCut 27-2	SOLID	-	-	-	-	-	●	●/-/-	●	●	●/-/-
Mowing head AutoCut C12-2	-	-	-	-	-	-	●	●/-/-	●	-	●/-/-
Mowing head AutoCut 27-2	SOLID	-	-	-	-	-	●	●/-/-	●	-	●/-/-
Mowing head AutoCut 27-2	SOLID	-	-	-	-	-	●	-/●/-	●	●	●/-/-
Mowing head AutoCut C 26-2	SOLID	-	-	-	-	-	●	●/-/-	-	●	●/-/○
Mowing head AutoCut C 26-2	SOLID	-	-	-	-	-	●	-/●/-	●	●	●/-/○
Mowing head AutoCut C 26-2	SOLID	4-point	-	-	-	-	●	●/-/-	●	●	●/-/●
Mowing head AutoCut C 26-2	SOLID	4-point	-	-	-	-	●	-/●/-	●	●	●/-/●
Brush Knife 300-3	SOLID	4-point	-	-	-	-	●	-/●/-	●	●	●/-/●
Mowing head AutoCut 2-2	-	-	-	-	-	-	●	-/-/●	●	-	●/-/-
Mowing head AutoCut C 5-2	FLEXIBLE	-	-	-	-	-	●	-/-/●	-	-	●/-/-

⑦ WEIGHT EXCLUDING BATTERY, INCLUDING CUTTING TOOL & GUARD
 ⑧ WEIGHT INCLUDING BATTERY, EXCLUDING CHARGER
 ⑨ WEIGHT EXCLUDING BATTERY, CUTTING TOOL & GUARD

Ⓞ WEIGHT EXCLUDING CABLE, INCLUDING CUTTING TOOL & GUARD

	Order number	Mowing line diameter (mm) ②	FS 38/FS 45 / FS 45 C-E	FS 55 RC-E / FS 70 R	FS 55 C-E	FS 91/FS 111 / FS 91 R/FS 111 R	FS 94 RC-E / FS 94 C-E
FIXCUT MOWING HEAD ①							
FIXCUT 31-2 (ALLOY)	4001 710 2105	2.4/2.7	-	●	●	●	-
TRIMCUT MOWING HEADS ①							
TRIMCUT C 32-2 ○□✂	4002 710 2198	2.4/2.7/3.0	-	●	●	●	●
TRIMCUT C 42-2 ○□✂	4003 710 2122	2.4/ 2.7 /3.0	-	-	-	-	-
TRIMCUT C 51-2 ○□✂	4005 710 2117	2.4/ 2.7 /3.0/3.3	-	-	-	-	-
AUTOCUT MOWING HEADS ①							
AUTOCUT C 3-2	4009 710 2100	1.6/2.0	-	-	-	-	-
AUTOCUT 2-2	4008 710 2100	1.6/2.0	-	-	-	-	-
AUTOCUT C 4-2 ○	4006 710 2121	2.0/2.0	-	-	-	-	-
AUTOCUT C 6-2 ○□✂	4006 710 2126	2.0/2.4	●	-	-	-	-
AUTOCUT C 12-2	4010 710 2100	2.4	-	-	-	-	-
AUTOCUT C 26-2 ○□✂	4002 710 2169	2.4/2.7	-	●	●	●	●
AUTOCUT 27-2 ○□✂	4002 820 2302	2.4/2.7	-	●	●	●	●
AUTOCUT 36-2 ○□✂	4002 710 2170	2.7/3.0/3.3	-	-	-	-	-
AUTOCUT 46-2 ○□✂	4003 710 2115	2.7/3.0/3.3	-	-	-	-	-
AUTOCUT 56-2 ○□✂	4005 710 2107	2.7/3.0/3.3	-	-	-	-	-
SUPERCUT MOWING HEADS ①							
SUPERCUT 20-2 ○	4002 710 2162	2.4	-	●	●	●	●
SUPERCUT 40-2 ○	4003 710 2140	2.4	-	-	-	-	-
POLYCUT MOWING HEADS ①							
POLYCUT 2-2 ③ ○	4008 710 2102	1.4/1.6	-	-	-	-	-
POLYCUT 3-2	4009 710 2104	-	-	-	-	-	-
POLYCUT 12-2	4010 710 2110	2.4	-	-	-	-	-
POLYCUT 6-2	4006 710 2137	-	●	-	-	-	-
POLYCUT 28-2	4002 820 2300	2.4/2.7	-	●	-	●	●
POLYCUT 48-2	4003 710 2126	2.4/2.7	-	-	-	-	-
DUROCUT MOWING HEADS ①							
DUROCUT 5-2 ④ ○□✂	4006 710 2131	1.6/2.0/2.4 L	●	-	-	-	-
DUROCUT 20-2 ⑤ ○□✂	4002 710 2182	2.0/2.4/2.7/L/XL	-	●	●	●	●
DUROCUT 40-4 ⑥ ○□✂	4005 710 2114	2.7/3.0/3.3/4.0/XL/XXL	-	-	-	-	-

● RECOMMENDED
○ CAN BE COMBINED
- NOT APPROVED

① ONLY WITH APPROVED GUARD
② NUMBERS IN BOLD TYPE SHOW YOU THE LINE DIAMETER WITH WHICH THE MOWING HEAD IS EQUIPPED WHEN FIRST SUPPLIED
③ CAN BE EQUIPPED WITH CUT-TO-LENGTH MOWING LINES AS AN ALTERNATIVE

④ INCLUDING 6 LINE PIECES L
⑤ INCLUDING 12 LINE PIECES XL
⑥ INCLUDING 12 LINE PIECES XXL

FS 131 / FS 131 R	FS 240 C-E	FS 260 C-E / FS 261 C-M	FS 360 C-EM / FS 361 C-EM	FS 460 C-EM / FS 461 C-EM / FSA 400	FS 560 C-EM / FS 561 C-EM	FSA 45	FSA 56 / FSE 52	FSA 50 / FSA 57 / FSE 52	FSA 65 / FSA 85	FSA 70 / FSA 110	FSA 60 R / FSA 86 R	FSA 90 R / FSA 90	FSA 135 R / FSA 135 / FSA 200 R / FSA 200 /	FSE 71
•	-	-	-	-	-	-	-	-	-	-	-	•	-	-
•	•	-	-	-	-	-	-	-	-	-	-	○	•	-
-	-	•	•	•	-	-	-	-	-	-	-	-	-	-
-	-	-	-	-	•	-	-	-	-	-	-	-	-	-
-	-	-	-	-	-	-	•	•	-	-	-	-	-	-
-	-	-	-	-	-	-	-	-	•	-	-	-	-	-
-	-	-	-	-	-	-	-	-	-	•	-	-	-	•
•	•	-	-	-	-	-	-	-	-	-	-	-	-	-
•	•	-	-	-	-	-	-	-	-	-	-	•	•	-
•	•	-	-	-	-	-	-	-	-	-	-	•	•	-
•	•	-	-	-	-	-	-	-	-	-	-	-	•	-
-	-	•	•	•	-	-	-	-	-	-	-	-	-	-
-	-	-	-	-	•	-	-	-	-	-	-	-	-	-
•	•	-	-	-	-	-	-	-	-	-	-	•	•	-
-	-	•	•	•	-	-	-	-	-	-	-	-	-	-
-	-	-	-	-	-	-	-	-	-	-	-	-	-	-
-	-	-	-	-	-	•	-	-	-	-	-	-	-	-
-	-	-	-	-	-	-	-	•	-	-	-	-	-	-
-	-	-	-	-	-	-	-	-	-	•	-	-	-	○
•	•	-	-	-	-	-	-	-	-	-	-	•	•	-
-	-	-	•	•	-	-	-	-	-	-	-	-	-	-
•	•	-	-	-	-	-	-	-	-	-	•	-	•	○
-	-	•	•	•	•	-	-	-	-	-	-	-	-	-

	Order number	FS 55 R / FS 55 / FS 70 R	FS 85 / FS 91 / FS 91 R	FS 111 / FS 111 R / FS 131 / FSA 135 / FSA 135 R / FSA 200 / FSA 200 R	FSA 90 R / FSA 90	FS 94 RCE / FS 94 CE	FS 240 / FS 240 R	FS 260 C-E / FS 261 C-E	FS 360 C-EM / FS 361 C-EM	FS 460 C-EM / FS 461 C-EM / FSA 400	FS 560 C-EM / FS 561 C-EM
GRASS CUTTING BLADES ①											
230MM (2 T)	40017133805	●	●	●	●	●	●	-	-	-	-
260MM (2 T)	40017133812	-	●	●	●	●	●	-	-	-	-
230MM (4 T)	40017133801	●	●	●	●	●	●	-	-	-	-
230MM (4 T)	40007133801	-	-	-	-	-	-	●	●	●	-
230MM (8 T)	40017133803	●	●	●	●	●	●	-	-	-	-
250MM (32 T)	40007133812	-	-	-	-	-	-	●	●	●	●
250MM (32 T)	40017133813	-	●	●	-	-	●	-	-	-	-
255MM (8 T)	40007133802	-	-	-	-	-	-	●	●	●	●
250MM (40 T) ②	40017133806	-	-	-	●/-	●	●	-	-	-	-
250MM (40 T) ②	40007133806	-	-	-	-	-	-	●	●	●	●
BRUSH KNIVES ①											
250MM (3 T)	41127134100	-	●	●	-	-	●	-	-	-	-
300MM (3 T)	41197134100	-	-	-	-	-	-	●	●	●	-
305MM "SPECIAL" (2 T) ②	40007134103	-	-	-	-	-	-	●	●	●	●
350MM (3 T)	41107134100	-	-	-	-	-	-	-	-	-	●
350MM "SPECIAL" (3 T) ②	40007134100	-	-	-	-	-	-	-	-	-	●
SHREDDER BLADES ④⑤											
270MM (2 T)	40007133903	-	-	-	-	-	-	●	●	●	-
320MM (2 T)	40007133902	-	-	-	-	-	-	-	-	-	●
CIRCULAR SAW BLADE - SCRATCHER TOOTH ⑤⑥											
200MM (80 T)	41127134201	-	-	-	-	-	●	-	-	-	-
CIRCULAR SAW BLADES - CHISEL TEETH ⑤⑥											
200MM (22 T)	41127134203	-	●	-	-	-	●	-	-	-	-
200MM (22 T)	41197134200	-	-	-	-	-	-	●	●	●	-
225MM (24 T)	40007134201	-	-	-	-	-	-	●	●	●	●
CIRCULAR SAW BLADES - HIGH PERFORMANCE ⑤⑥											
200MM (22 T) HP ⑦	40017134203	-	●	-	-	-	●	-	-	-	-
200MM (22 T)	40007134203	-	-	-	-	-	-	-	-	-	-
225MM (22 T) HP ⑦	40007134202	-	-	-	-	-	-	●	●	●	●
CIRCULAR SAW BLADE - CARBIDE TIPPED ⑤⑥											
225MM (36 T)	40007134211	-	-	-	-	-	-	●	●	●	●

i ENSURE CORRECT GUARD IS FITTED, REFER TO SSC

● RECOMMENDED
- NOT APPROVED

Z = TEETH

① ONLY APPROVED WITH GUARD
② VERY DURABLE, LONG SERVICE LIFE



③ LOW-SPIN
④ ONLY APPROVED WITH SHREDDER GUARD

⑤ ONLY APPROVED FOR FS WITH BIKE HANDLE
⑥ ONLY APPROVED WITH LIMIT STOP
⑦ HP = HIGH PERFORMANCE





ELECTRIC BLOWERS FOR HOME USE

		MAX AIR SPEED (M ² /H)	MAX AIR SPEED (KM/H)	WEIGHT (KG)	ORDER NUMBER	MIN ORDER	RRP INC. GST
BGE 61		237	252	3.0 [#]	4811 011 1514	1	\$199.00
BGE 81		273	295	3.3 [#]	4811 011 1550	1	\$249.00

PETROL BLOWERS - HANDHELD

		DISPLACEMENT (CM ³)	MAX AIR SPEED (M ² /H)	MAX AIR SPEED (KM/H)	WEIGHT (KG)	ORDER NUMBER	MIN ORDER	RRP INC. GST
BG 56		27.2	700*	ROUND NOZZLE 255.6	4.1 [^]	4241 011 1761	1	\$379.00
BG 86		27.2	755*	ROUND NOZZLE 273.6 FLAT NOZZLE 320.4	4.4 [^]	4241 011 1762	1	\$479.00

PETROL BACKPACK BLOWERS

		DISPLACEMENT (CM ³)	MAX AIR SPEED (M ² /H)	MAX AIR SPEED (KM/H)	WEIGHT (KG)	ORDER NUMBER	MIN ORDER	RRP INC. GST
BR 450 BACKPACK		63.3	1,090*	298.8	10.6 [^]	4244 011 1606	1	\$999.00
BR 450 C-EF BACKPACK ELECTROSTART (F)		63.3	1,090*	298.8	11.5 [^]	4244 011 1605	1	\$1,049.00
BR 700 BACKPACK		64.8	1,550*	316.8	10.7 [^]	4282 011 1642	1	\$1,249.00
BR 800 C-E MAGNUM BACKPACK		79.9	1,550*	385.2	11.7 [^]	4283 011 1602	1	\$1,349.00







*WEIGHT EXCLUDING FUEL, FULLY ASSEMBLED

*WITH ROUND NOZZLE

PETROL VACUUM SHREDDERS

	DISPLACEMENT (CM ³)	AIR THROUGHPUT VAC MODE (M ³ /H)	WEIGHT (KG)	ORDER NUMBER	MIN ORDER	RRP INC. GST
 <p>SH 56 C-E</p>	27.2	710	5.2 [^]	4241 011 0937	1	\$469.00
 <p>SH 86 C-E</p>	27.2	770	5.6 [^]	4241 011 0941	1	\$569.00









BLOWER ACCESSORIES

	ORDER NUMBER	RRP INC. GST		ORDER NUMBER	RRP INC. GST
<p>BLOWER VACUUM KIT BG 56/86 / SH 56/86</p> 	4241 700 2200	\$113.00 MIN ORDER: 1	<p>BLOWER VACUUM KIT SHE/BGE 81</p> 	4811 700 2201	\$143.00 MIN ORDER: 1
<p>BLOWER VACUUM BAG (FINE MATERIAL) 45L</p> 	4229 708 9701	\$82.00 MIN ORDER: 1	<p>BLOWER GUTTER KIT BG/BGE / SH/SHE</p> 	4241 007 1003	\$82.00 MIN ORDER: 1
<p>HIP BELT BR 350/450 / 450 C-EF / SR 450</p> 	4203 710 9102	\$72.00 MIN ORDER: 1	<p>HIP BELT BR 500/550 / 600/700</p> 	4282 710 9101	\$82.00 MIN ORDER: 1
<p>CHEST STRAP For compatible machines refer to SSC</p> 	0000 790 7700	\$23.00 MIN ORDER: 1			







[^]WEIGHT EXCLUDING FUEL, FULLY ASSEMBLED

#WEIGHT EXCLUDING CABLE

BLOWER ACCESSORIES - CURVED NOZZLES

	ORDER NUMBER	RRP INC. GST		ORDER NUMBER	RRP INC. GST		
CURVED FLAT BG 56 / 86 / BGE 61 / 81 / SH 56 / 86 / SHE 81		4241 708 6302	\$29.00 MIN ORDER: 1	CURVED FLAT BGA 85 / KM-BG		4606 701 8301	\$31.00 MIN ORDER: 1
CURVED NARROW BR 500 / 550 / 600		4282 708 6340	\$25.00 MIN ORDER: 1	CURVED NARROW BR 700 / BR 800 BRA 600		4282 708 6304	\$36.00 MIN ORDER: 1
ROUND NOZZLE CURVED BR 700 / 800		4282 708 6303	\$31.00 MIN ORDER: 1	BIKE HANDLE BR 350-800 BRA 600 To be used with curved narrow nozzle		4282 790 1700	\$151.00 MIN ORDER: 1
ROUND NOZZLE CURVED BR 450 / 450 C-EF		4244 708 6302	\$30.00 MIN ORDER: 1	ADJUSTABLE NOZZLE BR 700 / 800 BGA 300 BRA 600		0000 700 6300	\$90.00 MIN ORDER: 1

BLOWER ACCESSORIES - STRAIGHT NOZZLES

	ORDER NUMBER	RRP INC. GST		ORDER NUMBER	RRP INC. GST		
STRAIGHT NOZZLE BR 550		4282 708 6360	\$20.00 MIN ORDER: 1	STRAIGHT NOZZLE BR 500 *Image for illustration purposes only		4282 708 6370	\$20.00 MIN ORDER: 1
STRAIGHT NOZZLE BR 600 / BGA 250		4282 708 6350	\$20.00 MIN ORDER: 1	STRAIGHT NOZZLE BR 450 / 450 C-EF		4244 708 6301	\$20.00 MIN ORDER: 1
STRAIGHT NOZZLE BR 700		4282 708 6302	\$20.00 MIN ORDER: 1	STRAIGHT NOZZLE BR 800 C-E		4283 708 6300	\$20.00 MIN ORDER: 1
STRAIGHT NOZZLE BGA 56 / 57 / 86 / 100		4866 701 8300	\$30.00 MIN ORDER: 1				

BLOWER ACCESSORIES - FLAT NOZZLE

	ORDER NUMBER	RRP INC. GST	
FLAT NOZZLE BGA 56 / 57 / 86 / 100		4866 701 8301	\$25.00 MIN ORDER: 1

*FOR ADDITIONAL ACCESSORIES REFER TO SSC

	Order number	Displacement (cm ³)	Rated voltage (V)	Power consumption (kW)	Weight (kg)	Sound pressure level ^① (dB(A))	Sound power level ^② (dB(A))	Vibration level, right ^③ (m/s ²)	STIHL engine (2-MIX/4-MIX)
PETROL BLOWERS									
BG 56	4241 011 1761	27.2	-	-	4.1 ^④	90	104	7.5	2-MIX
BG 86	4241 011 1762	27.2	-	-	4.4 ^④	90	104	2.5	2-MIX
BR 450	4244 011 1606	63.3	-	-	10.6 ^④	102	109	2.5	2-MIX
BR 450 C-EF	4244 011 1605	63.3	-	-	11.5 ^④	102	109	2.5	2-MIX
BR 700	4282 011 1642	64.8	-	-	10.7 ^④	101	109	2.5	4-MIX
BR 800 C-E	4283 011 1602	79.9	-	-	11.7 ^④	104	114	3.5	4-MIX
BATTERY BLOWERS									
BGA 30	BA08 011 5900	-	10.8	-	1.58 ^⑤	73	84	0.5	-
BGA 50	BA05 011 5900	-	36	-	2.3 ^⑤	78	88	0.6	-
BGA 60	BA04 011 5900	-	36	-	2.3 ^⑤	76	89	1.2	-
BGA 86	BA02 011 5900	-	36	-	2.8 ^⑤	79	90	<0.5	-
BGA 100	4866 011 5900	-	36	-	2.5 ^⑤	80	90	<2.5	-
BGA 160	BA09 011 5900	-	36	-	2.6 ^⑤	80	90	0.7	-
BGA 200	BA01 011 5900	-	36	-	3.2 ^⑤	80	93	<2.5	-
BGA 250	BA06 011 5900	-	36	-	2.7 ^⑤	84	92	0.9	-
BGA 300	BA03 011 5910	-	36	-	7.4 ^⑤	84	94	0.2	-
NEW BRA 600	BA07 011 5910	-	72	-	10.5 ^⑤	86	96	0.2	-
ELECTRIC BLOWERS									
BGE 61	4811 011 1514	-	240	1.1	3.0 ^⑥	85	100	1.0	-
BGE 81	4811 011 1550	-	240	1.4	3.3 ^⑥	89	103	4.1	-

● AS STANDARD
○ RETROFITTABLE (ACCESSORY)

E = EASY2START
F = ELECTROSTART

① K FACTOR ACCORDING TO DIR. 2006/42/EC = 2.5 dB(A)
② K FACTOR ACCORDING TO DIR. 2006/42/EC = 2 M/S³
③ COMBINATION OF AIR SPEED & AIR THROUGHPUT

④ WITHOUT BLOWER ATTACHMENT/NOZZLE
⑤ WEIGHT EXCLUDING FUEL, FULLY ASSEMBLED
⑥ WEIGHT INCLUDING BATTERY

Blowing force (N) ^⑦	Avg. Air speed (m/s) with round nozzle / flat nozzle	Air throughput (m ³ /h) with round nozzle / flat nozzle	Max air speed (m/s) with round nozzle / flat nozzle	Max. air throughput (m ³ /h) ^⑧	STIHL anti-vibration system	STIHL ElastoStart	STIHL Easy2Start (E)	STIHL ElectroStart (F)	Round nozzle / flat nozzle	Chest belt / hip belt	Vacuum attachment
13	60/-	700/-	71/-	730	-	○	-	-	●/○	-/-	○
15	63/74	755/620	76/89	810	●	●	-	-	●/○	-	○
28	83/-	1,090/-	99/-	1,430	●	●	-	-	●/○	○/○	-
28	83/-	1,090/-	99/-	1,430	●	-	●	●	●/○	○/○	-
35	74/-	1,550/-	88/-	1,860	●	-	-	-	●/○	○/●	-
41	89/-	1,550/-	107/-	2,025	●	-	-	-	●/○	○/●	-
5	43/-	-/-	43/-	430	-	-	-	-	●/●	-/-	-
11	46/-	-/-	55/-	770	-	-	-	-	●/-	-/-	-
15	69 ^⑨ /-	620/560	55/60	620	-	-	-	-	●/○	-/-	-
15	58/-	780/710	69/76	850	-	-	-	-	●/●	-/-	-
17 ^⑩	63 ^⑨ /-	840 ^⑨ /-	75 ^⑨ /-	1,040	-	-	-	-	●/○	-/-	-
21	65/-	-/-	65/-	970	-	-	-	-	●/-	-/-	-
21 ^⑩	70 ^⑨ /-	940 ^⑨ /-	84 ^⑨ /-	1,040	-	-	-	-	●/-	-/-	-
26 ^⑩	71 ^⑨ /-	-/-	85 ^⑨ /-	1,040	-	-	-	-	●/-	-/-	-
26 ^⑩	86 ^⑨ /-	970 ^⑨ /-	84 ^⑨ /-	1,040	-	-	-	-	●/-	-/-	-
35 ^⑩	95 ^⑨ /-	1,500 ^⑨ /-	113 ^⑨ /-	1,765	●	-	-	-			-
9	-/58	-/485	-/70	670	-	-	-	-	○/●	-/-	-
12	-/68	-/565	-/82	750	-	-	-	-	○/●	-/-	○

⑦ WEIGHT EXCLUDING BATTERY
⑧ WEIGHT INCLUDING BATTERY, EXCLUDING CHARGER

⑨ WEIGHT EXCLUDING CABLE
⑩ IN BOOST

Order number	Displacement (cm ³)	Rated voltage (V)	Power consumption (kW)	Weight (kg), including accessories	Sound pressure level ^① (dB(A))	Sound power level ^② (dB(A))	Vibration level, left/right ^③ (m/s ²)	STIHL engine (2-MIX/4-MIX)	Air throughput (m ³ /h) in vacuum mode	Collection bag volume (l)	STIHL anti-vibration system	STIHL ElastoStart	STIHL Easy2Start (E)	Round nozzle / flat nozzle	Infinitely variable speed control	Blower function ^④	Manual fuel pump	
PETROL VACUUM SHREDDERS																		
SH 56 C-E	4241 011 0937	272	-	-	5.4 ^①	94	105	91/80	2-MIX	710	45	-	-	●	●/○	●	●	●
SH 86 C-E	4241 011 0941	272	-	-	5.6 ^①	93	106	2.5/19	2-MIX	770	45	●	●	●	●/●	●	●	●
BATTERY VACUUM SHREDDER																		
SHA 56	SA02 011 7100	-	36	-	4.2 ^②	83	96	0.8/0.8	-	510	40	-	-	-	-/●	●	●	-
SHA 140	SA07 011 7100	-	36	-	5.1 ^②	83	96	0.7 / 0.6	-	910	55	-	-	-	-/-	●	-	-



● AS STANDARD
○ RETROFITTABLE (ACCESSORY)

E = EASY2START

① WEIGHT EXCLUDING FUEL, FULLY ASSEMBLED
② WEIGHT EXCLUDING CABLE
③ K FACTOR ACCORDING TO DIR. 2006/42/EC = 2.5 dB(A)

④ K FACTOR ACCORDING TO DIR. 2006/42/EC = 2 M/S²
⑤ VACUUM SHREDDER CAN ALSO BE USED AS A BLOWER
⑥ WEIGHT EXCLUDING BATTERY

ELECTRIC HEDGE TRIMMERS FOR HOME USE

		POWER OUTPUT WATTS (W)	WEIGHT (KG)	ORDER NUMBER	MIN ORDER	RRP INC. GST
HSE 42 45CM/18"		420	3.0 [#]	4818 011 3522	1	\$199.00
HSE 61 50CM/20"		500	3.9 [#]	4812 011 3561	1	\$329.00

*WEIGHT EXCLUDING CABLE

	Order number	Bar length (inches)	Displacement (cm ³)	Power output (kW/hp)	Rated voltage (V)	Power consumption (W)	Weight (kg)
PETROL HEDGE TRIMMERS							
HS 45	4228 011 2947	45/18	272	0.75/1.0	-	-	4.7 ^③
HS 45	4228 011 2948	60/24	272	0.75/1.0	-	-	5.0 ^③
HS 56	4242 011 2909	60/24	214	0.65/0.9	-	-	4.5 ^③
HS 82 R	4237 011 2963	75/30	22.7	0.7/1.0	-	-	5.7 ^③
HS 82 T	4237 0121 2976	60/24	22.7	0.7/1.0	-	-	5.1 ^③
HS 87 T	4237 011 2964	100/40	22.7	0.7/1.0	-	-	5.5 ^③
HL 94	4243 200 0032	60/24	24.1	0.9/1.2	-	-	6.1 ^③
BATTERY HEDGE TRIMMERS, PRUNERS & SHEARS							
GTA 26	GA01 011 6915	10/4	-	-	10.8	-	1.45 ^④
HSA 26	HA03 011 3510	20/8	-	-	10.8	-	0.7 ^④
HSA 30	HA08 011 3500	45/18	-	-	10.8	-	2.0 ^④
HSA 40	HA08 011 3520	50/20	-	-	10.8	-	2.1 ^④
HSA 50	4521 011 3560	50/20	-	-	36	-	2.9 ^④
HSA 60	HA06 011 3530	60/24	-	-	36	-	3.5 ^④
HSA 100	HA07 011 3530	60/24	-	-	36	-	3.7 ^④
HSA 130 T	4869 011 3566	60/24	-	-	36	-	3.9 ^④
HSA 140 R	HA02 022 3505	75/30	-	-	36	-	4.3 ^④
HSA 140 T	HA02 011 3510	60/24	-	-	36	-	4.2 ^④
ELECTRIC HEDGE TRIMMERS							
HSE 42	4818 011 3522	45/18	-	-	240	420	3.0 ^③
HSE 61	4812 011 3561	50/20	-	-	240	500	3.9 ^③
BATTERY POLE HEDGE TRIMMERS							
NEW HLA 40	HA10 011 2900	45/18	-	-	10.8	-	3.5 ^④
HLA 56	HA01 011 2910	45/18	-	-	36	-	3.8 ^④
HLA 66	4859 011 2910	50/20	-	-	36	-	3.7 ^④
HLA 86	4859 011 2930	50/20	-	-	36	-	4.8 ^④
HLA 135 K	HA04 200 0005	60/24	-	-	36	-	5.2 ^④
HLA 135	HA04 200 0016	60/24	-	-	36	-	5.6 ^④

● AS STANDARD

E=EASY2START
R=PRUNING
T=TRIMMING

① K FACTOR ACCORDING TO DIR. 2006/42/EC = 2.5 dB(A)
② K FACTOR ACCORDING TO DIR. 2006/42/EC = 2 M/S²

③ WEIGHT EXCLUDING FUEL, FULLY ASSEMBLED
④ WEIGHT EXCLUDING BATTERY, INCLUDING CUTTING TOOL

PETROL HEDGE TRIMMERS FOR HOME USE

		DISPLACEMENT (CM ³)	POWER OUTPUT (KW/HP)	WEIGHT (KG)	ORDER NUMBER	MIN ORDER	RRP INC. GST
HS 45 45CM/18"		27.2	0.75/1.0	4.7 [^]	4228 011 2947	1	\$379.00
HS 45 60CM/24"		27.2	0.75/1.0	5.0 [^]	4228 011 2948	1	\$429.00
HS 56 60CM/24"		21.4	0.65/0.9	4.6 [^]	4242 011 2909	1	\$749.00
HL 94 60CM/24"	 Total length 2.42m 145°	24.1	0.90/1.2	6.1 [^]	4243 200 0032	1	\$949.00

Sound pressure level ^① (dB(A))	Sound power level ^② (dB(A))	Vibration level left/right ^③ (m/s ²)	STIHL engine (2-MIX/4-MIX)	Total length (cm)	Stroke rate (rpm)	Tooth spacing (mm)	STIHL anti-vibration system	STIHL Easy2Start (E)	Long-life air filter system	Rotary handle
97	107	10.0/9.0	-	91	3,800	30	●	-	●	-
97	107	10.0/9.0	-	110	3,800	30	●	-	●	-
95	107	4.7/5.5	2-MIX	104	3,600	34	●	-	●	-
94	106	2.7/3.0	2-MIX	135	3,200	38	●	-	●	●
95	107	2.3/2.3	2-MIX	121	5,100	30	●	-	●	●
97	107	3.4/4.1	2-MIX	122	5,100	30	●	-	●	-
91	106	4.1/4.5	2-MIX	242	3,615	34	●	-	●	-
<77	<86	<2.9/2.8	-	-	-	-	-	-	-	-
<69	<80	<1	-	-	2,200	19	-	-	-	-
82	90	1.9/1.4	-	89	2,800	22	-	-	-	-
82	90	1.9/1.4	-	94	2,800	24	-	-	-	-
81	91	2.0/1.6	-	101	2,800	30	-	-	-	-
77	85	2.7/1.2	-	117	3,000	30	-	-	-	-
76	84	1.0/0.8	-	116	3,000	34	●	-	-	●
85	96	4.0/3.1	-	118	4,400/4,700/5,000 ^④	30	-	-	-	●
79	87	2.5/3.0	-	-	2,600 / 3,000 / 3,400 ^⑤	38	●	-	-	●
82	90	1.3-1.9	-	-	3,900 / 4,500 / 5,000 ^⑥	30	●	-	-	●
84	95	3.1/1.5	-	92	3,400	21	-	-	-	-
85	96	5.3/3.3	-	113	3,200	29	-	-	-	●
74	84	1.5/1.5	-	200-260	2,600	22	-	-	-	-
77	88	1.5/1.5	-	115-210	2,800	30	-	-	-	-
85	94	3.5/3.5	-	205	3,000	33	-	-	-	-
80	91	2.3/1.6	-	260-330	3,000	33	-	-	-	-
84	95	3.5/3.0	-	219	4,000	34	-	-	●	-
85	96	3.9 / 2.8	-	249	4,000	34	-	-	●	-

① WEIGHT INCLUDING BATTERY
② WEIGHT EXCLUDING BATTERY

③ WEIGHT INCLUDING BATTERY, EXCLUDING CHARGER
④ WEIGHT EXCLUDING CABLE

⑤ WITH SHRUB CUTTER / WITH GRASS TRIMMER
⑥ LEVEL 1 / LEVEL 2 / LEVEL 3

[^]WEIGHT EXCLUDING FUEL, FULLY ASSEMBLED

PETROL HEDGE TRIMMERS FOR PROFESSIONAL USE

		DISPLACEMENT (CM ³)	POWER OUTPUT (KW/HP)	WEIGHT (KG)	ORDER NUMBER	MIN ORDER	RRP INC. GST
HS 82 T 60CM/24"		22.7	0.7/1.0	5.1 [^]	4237 011 2976	1	\$999.00
HS 82 R 75CM/30"		22.7	0.7/1.0	5.3 [^]	4237 011 2963	1	\$999.00
HS 87 T 100CM/40" Single-sided blade		22.7	0.7/1.0	5.2 [^]	4237 011 2964	1	\$1,199.00

CLEANERS



		VOLUME	ORDER NUMBER	MIN ORDER	RRP INC. GST
SUPERCLEAN Lubricates & removes resin & dirt		300ML	7004 871 0438	6	\$18.00

ACCESSORIES

		ORDER NUMBER	MIN ORDER	RRP INC. GST
CATCHER PLATE HS 45 / HSA / HLA / HSE		4859 740 3300	1	\$50.00
CATCHER PLATE HSA 140		600 MM HA02 740 3300	1	\$55.00
		750 MM HA02 740 3302	1	\$65.00

[^]WEIGHT EXCLUDING FUEL, FULLY ASSEMBLED

PETROL KOMBIENGINES

		DISPLACEMENT (CM ³)	POWER OUTPUT (KW/HP)	WEIGHT (KG)	ORDER NUMBER	MIN ORDER	RRP INC. GST
KM 56 RC-E		27.2	0.8/1.1	4.3 [^]	4144 200 0214	1	\$399.00
KM 94 RC-E		24.1	0.9/1.2	4.0 [^]	4149 200 0091	1	\$549.00
KM 131 R		36.3	1.4/1.9	4.4 [^]	4180 200 0702	1	\$799.00

i SEE **PAGE 11** FOR KMA 80 R, KMA 135 R & KMA 200 R

*WEIGHT EXCLUDING FUEL, FULLY ASSEMBLED

Order number	Displacement (cm ³)	Power output (kW/hp)	Weight (kg)	Sound pressure level ^① (dB(A)) ^②	Sound power level ^① (dB(A)) ^②	Vibration level, left/right ^③ (m/s ²) ^④	STIHL engine (2-MIX/4-MIX)	STIHL Easy2Start (E)	Voltage	Automatic decompression	
KOMBIENGINES											
KMA 80 R	FA08 011 6800	-	1.0/1.3	3.1 ^③	90	102	5.0/3.2	EC Motor	-	36v	-
KMA 135 R	FA02 011 6810	-	1.2/1.6	3.4 ^③	91	104	5.0/3.7	EC Motor	-	36v	-
KMA 200 R	FA03 011 6800	-	1.5 / 2.0	3.9 ^③	74	87	6.7 / 4.4	EC Motor	-	36v	-
KM 56 RC-E	4144 200 0214	27.2	0.8/1.1	4.3 ^③	96	109	8.5/8.2	2-MIX	●	-	-
KM 94 RC-E	4149 200 0091	24.1	0.9/1.2	4.0 ^③	95	110	8.2/7.9	2-MIX	●	-	-
KM 131 R	4180 200 0702	36.3	1.4/1.9	4.4 ^③	101	110	6.1/6.5	4-MIX	-	-	●

● AS STANDARD

E = EASY2START
R = LOOP HANDLE















① K FACTOR ACCORDING TO DIR. 2006/42/EC = 2.5 dB(A)
② MAXIMUM VALUES FOR KOMBITOOLS THAT CAN BE USED

③ WEIGHT EXCLUDING FUEL
④ WEIGHT EXCLUDING BATTERY

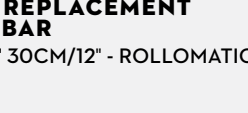
KOMBITOOL ATTACHMENTS

	ORDER NUMBER	RRP INC. GST		ORDER NUMBER	RRP INC. GST		
BRUSHCUTTER FSS-KM AUTOCUT C 26-2 45CM CUT DIAMETER Compatible with KMA 200 R and KM 131 R Only		FA03 200 0018	\$259.00 MIN ORDER: 1	HARVESTER SP-KM Use on low speed settings with KMA 135 R (Not compatible with KM 131 R)		4249 740 5000	\$749.00 MIN ORDER: 1
BRUSHCUTTER FS-KM AUTOCUT C 27-2 42CM CUT DIAMETER		4180 200 0474	\$219.00 MIN ORDER: 1	PICK TINES 220MM BF-KM		4601 740 5000	\$429.00 MIN ORDER: 1
BRUSHCUTTER METAL BLADE FS-KM GSB 230-2		4180 200 0475	\$219.00 MIN ORDER: 1	BLOWER BG-KM		4606 740 5000	\$269.00 MIN ORDER: 1
BED REDEFINER METAL BLADE FBD-KM		4180 740 5001	\$269.00 MIN ORDER: 1	POLE PRUNER HT-KM		4182 200 0212	\$319.00 MIN ORDER: 1
EDGER STRAIGHT SHAFT FCS-KM		4180 740 5008	\$319.00 MIN ORDER: 1	SCRUB CUTTER FH-KM 145° 25CM		4243 740 5006	\$479.00 MIN ORDER: 1
EDGER BENT SHAFT FCB-KM		4180 740 5002	\$269.00 MIN ORDER: 1	HEDGE TRIMMER 145° HL-KM 50CM		4243 740 5003	\$429.00 MIN ORDER: 1
SWEEPER RUBBER PADDLES KW-KM		4601 740 4904	\$749.00 MIN ORDER: 1	CARBON SHAFT EXTENSION HT/HL ATTACHMENTS - 1M		0000 710 7102	\$200.00 MIN ORDER: 1
BRISTLE BRUSH SWEEPER KB-KM		4601 740 4905	\$649.00 MIN ORDER: 1	ROTARY TRIMMER RG-KM Not suitable to use with KM 56 RC-E		4180 740 5006	\$529.00 MIN ORDER: 1







KOMBITOOL ACCESSORIES

	ORDER NUMBER	RRP INC. GST		ORDER NUMBER	RRP INC. GST
BLADE 200MM X 2.4MM FSB-KM / FCS-KM 	4133 713 4101	\$8.00 MIN ORDER: 1	GEARHEAD ANGLED 30° For machine suitability refer to SSC 	4138 640 0201	\$301.00 MIN ORDER: 1
HD BLADE 200MM X 3.8MM FSB-KM / FCS-KM 	4133 713 4102	\$10.00 MIN ORDER: 1	CURVED FLAT NOZZLE BGA 85 / BG-KM 	4606 701 8301	\$31.00 MIN ORDER: 1
FBD-KM SPARE BLADE 	4180 710 6001	\$34.00 MIN ORDER: 1	CARRY BAG KM / KMA 	0000 881 0507	\$82.00 MIN ORDER: 1
RG BLADES Includes two blades & a rider plate 	4180 007 4100	\$170.00 MIN ORDER: 1	HT-KM REPLACEMENT CHAIN LOOP PM3 1/4" .043" - 64DL - 30CM/12" 	3670 000 0064	\$46.00 MIN ORDER: 1
TIP PROTECTOR 145° For machine suitability refer to SSC 	4237 792 9006	\$31.00 MIN ORDER: 1	HT-KM REPLACEMENT GUIDE BAR 1/4" .043" 30CM/12" - ROLLOMATIC LIGHT 01 	3005 008 3405	\$62.00 MIN ORDER: 1
SHOULDER LOOP To suit KM 56 RC-E 	4130 710 9000	\$15.00 MIN ORDER: 1	AUTOCUT 27-2 Suits FS-KM 	4002 820 2302	\$36.00 MIN ORDER: 1
SUPERCLEAN Lubricates & removes resin & dirt 300ML 	7004 871 0438	\$18.00 MIN ORDER: 6	GRASS BLADE 230-2 Suits FS-KM 	4001 713 3805	\$31.00 MIN ORDER: 1
FOOT MOUNTING KIT KMA 135 R 	LA01 007 1002	\$61.00 MIN ORDER: 1	FOOT MOUNTING KIT KMA 80 R 	FA08 007 1001	\$61.00 MIN ORDER: 1





PETROL MULTIENGINE

	DISPLACEMENT (CM ³)	POWER OUTPUT (KW/HP)	WEIGHT (KG)	ORDER NUMBER	MIN ORDER	RRP INC. GST
MM 56 Complete with Wheel Kit & BF-MM (Guard supplied is NOT compatible with KW/KB/MF attachments) 	27.2	0.85/1.2	8.3	4604 200 0003	1	\$849.00



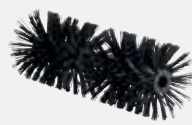
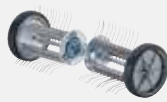

MULTITOOL ATTACHMENTS

	ORDER NUMBER	RRP INC. GST		ORDER NUMBER	RRP INC. GST
PICK TINES BF-MM 	4601 740 4605	\$139.00 MIN ORDER: 1	WEIGHT KIT MM 55/56 	4601 730 4500	\$87.00 MIN ORDER: 1
EDGE TRIMMER FC-MM 	4601 740 4603	\$99.00 MIN ORDER: 1	WHEEL KIT MM 55 / MM 56 	4601 007 1008	\$61.00 MIN ORDER: 1
CULTIVATOR BLADE MM 55/56 	4601 740 4800	\$31.00 MIN ORDER: 1	AERATOR RL-MM 	4601 740 4600	\$139.00 MIN ORDER: 1
BOLO TINES BK-MM 	4601 740 4606	\$139.00 MIN ORDER: 1			

MULTITOOLS THAT REQUIRE ADDITIONAL GUARDS

	ORDER NUMBER	RRP INC. GST		ORDER NUMBER	RRP INC. GST
POWER SWEEPER KW-MM Centre guard and side guards sold separately 	4601 740 4604	\$429.00 MIN ORDER: 1	BRISTLE BRUSH KB-MM Includes side guards only . Centre guard sold separately 	4601 740 4608	\$319.00 MIN ORDER: 1
DETHATCHER MF-MM Includes side guards and centre guard 	4601 740 4607	\$269.00 MIN ORDER: 1	CENTRE GUARD KW/KB/MF / MM 55/MM 56 	4601 710 8111	\$66.00 MIN ORDER: 1
LEFT GUARD KW/KB/MF / MM 55/MM 56 	4601 740 2801	\$34.60 MIN ORDER: 1	RIGHT GUARD KW/KB/MF / MM 55/MM 56 	4601 740 2800	\$32.50 MIN ORDER: 1

ELECTRIC GARDEN SHREDDERS

		WEIGHT (KG)	MAX BRANCH DIAMETER	POWER OUTPUT WATTS (W)	RPM	ORDER NUMBER	MIN ORDER	RRP INC. GST
GHE 135 L		23	35MM	2,000	40	6013 011 1124	1	\$549.00
GHE 105		19	35MM	2,200	2,800	6007 011 1194	1	\$699.00
GHE 150		26	35MM	2,200	2,800	6008 011 1134	1	\$849.00
AHB 050.0 SHREDDER BAG 50L						6903 760 2546	1	\$69.00

Order number

Max. branch thickness (Ø in mm)

Nominal output (W)

Rated voltage

Cutting tool (nominal speed)

Weight (kg)

Guaranteed sound power level L_{WA} (dB(A))

Measured sound pressure level L_{pA} (dB(A))

Sound pressure level uncertainty factor K_{pA} (dB(A))

Sandwich-type blade unit

Reversal mechanism

Cloverleaf opening

GARDEN SHREDDERS



GHE 135 L	6013 011 1124	35	2,000	240 V	Cutting roller (40 rpm)	23	94	87	3	-	-	●
GHE 105	6007 011 1194	35	2,200	240 V	Multi-Cut 103 (2,800 rpm)	19	104	93	3	-	-	●
GHE 150	6008 011 1134	35	2,200	240 V	Multi-Cut 150 (2,800 rpm)	26	99	89	2	●	-	●

● STANDARD

L = LOW NOISE

⊙ UNCERTAINTY FACTOR K_{PA} ACCORDING TO RL 2006/42/ECRS

ELECTRIC HIGH-PRESSURE CLEANERS

		OPERATING PRESSURE (BAR)	OPERATING PRESSURE (PSI)	MAX PRESSURE (BAR)	WEIGHT (KG)	ORDER NUMBER	MIN ORDER	RRP INC. GST
RE 90		10 - 100	1,450	120	9.8	RE02 011 4520	1	\$239.00
RE 90 PLUS		10 - 100	1,450	120	9.8	RE02 011 4526	1	\$299.00
RE 110		10 - 110	1,595	150	17.6	4950 011 4524	1	\$399.00
RE 110 PLUS		10 - 110	1,595	150	20.3	4950 011 4536	1	\$449.00

Order number

Operating pressure (bar)

Max. pressure (bar)^①

Min. water throughput (l/h)

Max. water throughput (l/h)

Max. water supply temperature (°C)

Weight, ready for operation (kg)

Power consumption (kW)

Sound pressure level^② (dB(A))Sound power level^③ (dB(A))Vibration level^④ (m/s²)

Power cable length (m)

Mains voltage (V/phases/Hz)

HIGH-PRESSURE CLEANERS - COMPACT RANGE^①

RE 90	RE02 011 4520	10-100	120	350	520	40	9.6	1.8	800	88.8	<2.5	5	240/1-/50
RE 90 PLUS	RE02 011 4526	10-100	120	350	520	40	9.6	1.8	800	88.8	<2.5	5	240/1-/50
RE 110	4950 011 4524	10-110	120	380	440	40	17.6	1.7	670	81.0	<2.5	5	240/1-/50
RE 110 PLUS	4950 011 4536	10-110	150	380	440	40	20.3	1.7	670	81.0	<2.5	5	240/1-/50
RE 120 PLUS	4950 011 4553	10-125	160	400	500	40	21.2	2.1	670	81.0	<3.8	5	240/1-/50
RE 125 X	4950 011 4590	10 - 130	170	425	500	40	16.4	2.3	68	80	<2.5	5	240/1-/50
RE 130 PLUS	4950 011 4564	10-135	170	420	500	40	21.2	2.3	720	86.0	<2.5	5	240/1-/50

HIGH-PRESSURE CLEANER - MID RANGE^①

RE 170 PLUS	RE01 011 4544	10-120	180	468	522	60 ^②	27.6	2.4 ^③	79.7	92.8	<2.5	5	240/1-/50
--------------------	----------------------	--------	-----	-----	-----	-----------------	------	------------------	------	------	------	---	-----------

BATTERY HIGH-PRESSURE CLEANER^①

RCA 20	RA02 011 7600	22	24	140	230	40	1.52	-	2	84	<2.5	-	-
REA 60 PLUS	RA01 011 7600	10-100	130	240	270	40	7	1.0	89	85	<2.5	-	-
REA 100 PLUS	RA01 011 7610	10-125	150	270	300	40	7	1.3	89	87	<2.5	-	-





① MAX. PERMISSIBLE SYSTEM PRESSURE

② K FACTOR ACCORDING TO DIR. 2006/42/EC = 1.5 dB(A)

③ K FACTOR ACCORDING TO DIR. 2006/42/EC = 2 M/S² WITH FAN JET NOZZLE

④ PLEASE COMPLY WITH LOCAL WASTE WATER REGULATIONS WHEN USING STIHL HIGH-PRESSURE CLEANERS

ELECTRIC HIGH-PRESSURE CLEANERS

	OPERATING PRESSURE (BAR)	OPERATING PRESSURE (PSI)	MAX PRESSURE (BAR)	WEIGHT (KG)	ORDER NUMBER	MIN ORDER	RRP INC. GST
 RE 120 PLUS	10 - 125	1,813	160	21.2	4950 011 4553	1	\$549.00
 RE 125 X	10 - 130	1,958	170	16.4	4950 011 4590	1	\$499.00
 RE 130 PLUS	10 - 135	1,958	170	21.2	4950 011 4564	1	\$669.00
 RE 170 PLUS	10 - 120	1,740	180	31	RE01 011 4544	1	\$1,099.00

Engine speed (RPM)	Transparent detergent tank (l)	High-pressure hose (length in m)	Aluminium pump head / brass pump head / ceramic pistons	Pressure / flow control on the tool / trigger	Pressure gauge	Aluminium telescopic handle	Aluminium transport handle	Fold-out front cover with nozzle storage	Detergent dispensing bottle	Bracket for flat textile hose	Flat textile hose with holder	Quick-release coupling on the high-pressure outlet	Integrated high-pressure hose reel	Anti-twist coupling on the lance	Rotary Nozzle / Fan jet nozzle
15,000	-	6	●/-/-	-/-	-	-	-	-	●	-	○	●	-	●	●/●
15,000	-	6	●/-/-	-/-	-	-	-	-	●	-	○	●	-	●	●/●
2,850	-	7	●/-/-	-/-	-	●	●	●	●	○	○	●	-	●	●/●
2,850	-	8	●/-/-	-/-	-	●	●	●	●	○	○	●	-	●	●/●
2,850	-	9	●/-/-	-/-	-	●	●	●	●	○	○	●	-	●	●/●
2,850	-	8	●/-/-	-/-	-	-	-	-	●	-	-	●	-	●	●/●
2,850	-	9	●/-/-	-/-	-	●	●	●	●	○	○	-	●	●	●/●
2,800	2	12	-/●/●	●/-	●	●	●	●	-	●	○	-	●	●	●/●
-	-	-	-	-	-	-	-	-	●	-	-	-	-	-	3-in-1
-	-	5	●/-/-	●/-	-	-	-	-	-	-	○	●	●	●	3-in-1
-	-	6	●/-/-	●/-	-	-	-	-	-	-	○	●	●	●	3-in-1

⑤ WITH FLAT TEXTILE HOSE ATTACHED MAX. WATER INTAKE TEMPERATURE = 20°C
 ⑥ THE ELECTRICAL INSTALLATION ON SITE MUST HAVE THE NECESSARY POWER CAPACITY

⑦ TEXTILE MESH

● AS STANDARD
 ○ RETROFITTABLE (ACCESSORY)

ELECTRIC HIGH-PRESSURE CLEANER ACCESSORIES





	ORDER NUMBER	RRP INC. GST		ORDER NUMBER	RRP INC. GST
TROLLEY WITH 20L TANK (Optional accessory suits REA 60 PLUS and REA 100 PLUS only) 	RA01 500 9800	\$159.00 MIN ORDER: 1	SUCTION HOSE REA 60 - 100 PLUS 	RA01 500 0500	\$69.00 MIN ORDER: 1
ROTATING ROLLER BRUSH RE 90 - 170 PLUS REA 60 - 100 PLUS 	4910 550 3400	\$145.00 MIN ORDER: 1	REPLACEMENT ROTATING ROLLER BRUSH SET 	4910 500 3400	\$62.50 MIN ORDER: 1
TELESCOPIC LANCE RE 90 - 170 PLUS REA 60 - 100 PLUS 	4910 550 3500	\$299.00 MIN ORDER: 1	SPLASH GUARD RE 90 - 170 PLUS REA 60 - 100 PLUS 	4910 550 9000	\$59.00 MIN ORDER: 1
FOAM NOZZLE RE 90 - 130 PLUS REA 60 - 100 PLUS 	4910 500 9600	\$45.00 MIN ORDER: 1	FOAM NOZZLE RE 170 PLUS ONLY 	4910 500 9601	\$45.00 MIN ORDER: 1
SURFACE CLEANER RA 90 DIAMETER 255MM RE 90 - 170 PLUS REA 60 - 100 PLUS 	4910 500 3904	\$82.00 MIN ORDER: 1	LANCE EXTENSION RE 90 - 170 PLUS REA 60 - 100 PLUS 	4910 500 0901	\$50.00 MIN ORDER: 1
SURFACE CLEANER RA 110 DIAMETER 310MM RE 90 - 170 PLUS REA 60 - 100 PLUS 	4910 500 3903	\$113.00 MIN ORDER: 1	ROTARY BRUSH DIAMETER 155MM RE 90 - 170 PLUS REA 60 - 100 PLUS 	4910 500 5911	\$88.00 MIN ORDER: 1
STANDARD FILTER RE 90 - 170 PLUS REA 60 - 100 PLUS 	4910 500 5400	\$31.00 MIN ORDER: 1	PIPE CLEAN SET RE 90 - 170 PLUS 	4910 500 8000	\$194.00 MIN ORDER: 1
PROFESSIONAL FILTER RE 90 - 170 PLUS 	4900 500 5401	\$54.00 MIN ORDER: 1	SUCTION SET RE 90 - 170 PLUS REA 60 - 100 PLUS 	4910 500 0500	\$123.00 MIN ORDER: 1
CAR CLEAN SET RE 90 - 130 PLUS 	4910 500 6100 Suits click systems	\$159.00 MIN ORDER: 1	WET SAND BLASTING KIT RE 90 - 170 PLUS 	4910 500 1800	\$194.00 MIN ORDER: 1
FLAT TEXTILE HOSE WITH HOLDER 12M RE 90 - 170 PLUS REA 60 - 100 PLUS 	4910 500 8600	\$123.00 MIN ORDER: 1	STEEL EXTENSION HOSES 	4910 500 0802 9m suits RE 90 - RE 170 PLUS	\$184.00 MIN ORDER: 1
WASH BRUSH RE 90 - 170 PLUS REA 60 - 100 PLUS 	4910 500 6000	\$103.00 MIN ORDER: 1	ANGLED SPRAY LANCE - 1080MM RE 90 - 170 PLUS 	4910 500 0803 20m suits RE 170 PLUS only	\$148.00 MIN ORDER: 1
				4910 500 1900	\$133.00 MIN ORDER: 1

i PLEASE CONSULT SSC FOR RE ACCESSORIES AND SPARE PARTS





Note: Please use SSC serial number search when selecting RE accessories

Note: For RE 163 PLUS accessories refer to SSC using serial number search function

PETROL HIGH-PRESSURE CLEANERS

		DISPLACEMENT (CM ³)	POWER OUTPUT (KW)	OPERATING PRESSURE (PSI)	FLOW RATE (L/MIN)	HORSEPOWER (HP)	ORDER NUMBER	MIN ORDER	RRP INC. GST
RB 200		173	3.7	2,500	8.6	5	4789 012 4608	1	\$1,199.00
RB 400		196	4.8	2,700	10.3	6.5	4790 012 4604	1	\$1,499.00
RB 600		208	5.2	3,200	11.3	7	4791 012 4604	1	\$2,199.00
RB 800		429	10.5	4,200	15.1	14	4792 012 4604	1	\$2,599.00

HIGH-PRESSURE CLEANER DETERGENTS

		ORDER NUMBER	RRP INC. GST		ORDER NUMBER	RRP INC. GST
1L CC 100 Vehicle cleaner		0782 516 9300	\$11.00 MIN ORDER: 6	1L CU 100 Universal cleaner		0782 516 9100 \$11.00 MIN ORDER: 6
5L CC 100 Vehicle cleaner		0782 516 9301	\$31.00 MIN ORDER: 4	5L CU 100 Universal cleaner		0782 516 9101 \$31.00 MIN ORDER: 4

- Order number
- Operating pressure (bar)
- Max. water throughput (l/h)
- Max. water supply temperature (°C)
- Weight, ready for operation (kg)
- Sound pressure level[Ⓚ] (dB(A))
- Sound power level[Ⓚ] (dB(A))
- High-pressure hose (length in m), steel-reinforced
- Aluminium pump head / brass pump head / ceramic pistons
- Pressure / flow control on the tool / trigger
- Quick-release coupling on the high-pressure outlet
- Anti-twist coupling on the lance
- Rotary nozzle / 2nd spray lance with rotary nozzle

CLEANING SYSTEMS - PETROL HIGH-PRESSURE CLEANERS

RB 200	4789 012 4608	170	520	52	28.0	90.8	103.7	7.6	●/-/-	-	-	-	○
RB 400	4790 012 4604	190	620	52	41.0	93.5	102.0	7.6	-/●/●	-	-	-	○
RB 600	4791 012 4604	220	680	52	53.5	90.2	103.0	12	-/●/●	●	●	●	○
RB 800	4792 012 4604	290	910	52	76.0	93.3	106.1	15.2	-/●/●	●	●	●	○

● AS STANDARD
○ RETROFITTABLE (ACCESSORY)

Ⓚ K FACTOR ACCORDING TO DIR. 2006/42/EC = 1.5 dB(A)



PETROL HIGH-PRESSURE CLEANER ACCESSORIES

	ORDER NUMBER	RRP INC. GST		ORDER NUMBER	RRP INC. GST
SPRAY GUN RB 200 / RB 400 M22 FITTING 	4789 500 1300	\$87.00 MIN ORDER: 1	ROTATING SURFACE CLEANER RB 200 - RB 800 	4900 500 3904	\$276.00 MIN ORDER: 1
SPRAY GUN RB 600 / RB 800 QC FITTING 	4791 500 1302	\$103.00 MIN ORDER: 1	WATER BROOM RB 200 - RB 800 	4789 500 3900	\$148.00 MIN ORDER: 1
SPRAY LANCE RB 200 / RB 400 / RB 600 	4915 500 0938	\$72.00 MIN ORDER: 1	SET OF 3 NOZZLES RB 200 	4789 007 1000	\$36.00 MIN ORDER: 1
SPRAY LANCE RB 800 	4915 500 0943	\$72.00 MIN ORDER: 1	SET OF 5 NOZZLES RB 400 	4790 007 1000	\$62.00 MIN ORDER: 1
EXTENSION LANCE 1.22M RB 200 - RB 800 	4915 500 0300	\$72.00 MIN ORDER: 1	SET OF 5 NOZZLES RB 600 	4791 007 1000	\$62.00 MIN ORDER: 1
ROTATING NOZZLE 3000 PSI MAX RB 200 / RB 400 	4900 500 1646	\$87.00 MIN ORDER: 1	SET OF 5 NOZZLES RB 800 	4792 007 1000	\$62.00 MIN ORDER: 1
ROTATING NOZZLE 5100 PSI MAX RB 600 / RB 800 	4900 500 1642	\$276.00 MIN ORDER: 1	LONG RANGE DETERGENT NOZZLE RB 200 - RB 800 	4900 502 1023	\$16.00 MIN ORDER: 1
3.0 MULTI-FUNCTION NOZZLE 4000 PSI MAX RB 200 - RB 800 	4900 502 1022	\$87.00 MIN ORDER: 1	GUTTER CLEANER RB 200 - RB 800 	4789 007 1008	\$36.00 MIN ORDER: 1
EXTENSION HOSE 7.5M M22 RB 200 / RB 400 Used as a replacement or extension 	4925 500 0819	\$113.00 MIN ORDER: 1	PIVOT COUPLING RB 200 - RB 800 	4789 500 6700	\$62.00 MIN ORDER: 1
EXTENSION HOSE 12M QC RB 600 	4925 500 0809	\$276.00 MIN ORDER: 1	LANCE TIP QC RB 200 - RB 800 	4900 500 6704	\$23.00 MIN ORDER: 1
EXTENSION HOSE 15M QC RB 800 	4925 500 0811	\$378.00 MIN ORDER: 1	 PLEASE CONSULT SSC FOR RB ACCESSORIES AND SPARE PARTS		

ENGINE OIL

	VOLUME	ORDER NUMBER	MIN ORDER	RRP INC. GST
GRADE 10W-30 RB 200 / 400 / 600 / 800 	600ML	0781 309 1000	12	\$10.00

ELECTRIC VACUUM CLEANERS

	SUCTION FLOW (L/MIN)	CONTAINER VOLUME (L)	WEIGHT (KG)	ORDER NUMBER	MIN ORDER	RRP INC. GST
SE 33 WET & DRY 	3,600	12	5.4#	SE01 012 4404	1	\$199.00
SE 62 WET & DRY 	3,600	20	7.5#	4784 012 4405	1	\$299.00
SE 122 WET & DRY 	3,700	30	12.1#	4774 012 4401	1	\$579.00

VACUUM CLEANER ACCESSORIES

	ORDER NUMBER	RRP INC. GST		ORDER NUMBER	RRP INC. GST
FILTER SE 33 	SE01 703 5900	\$34.00 MIN ORDER: 1	FILTER BAG 5PK - SE 33 	SE01 500 9000	\$24.00 MIN ORDER: 1
FILTER PAPER FILTER SE 62 	4709 703 5900	\$45.00 MIN ORDER: 1	WASTE BAGS 5PK - SE 133 M-E 	4901 903 4900	\$87.00 MIN ORDER: 1
FILTER WASHABLE FILTER SE 122 	4742 703 5900	\$70.00 MIN ORDER: 1	COARSE VACUUM SET SE 122/133 M-E 	4901 500 9300	\$123.00 MIN ORDER: 1
PTFE FLAT-FOLD FILTER SE 133 M-E 	4786 703 5902	\$132.00 MIN ORDER: 1	CAR CLEANING SET SE 33 / 62 / 122 / 133 M-E 	4901 500 9500	\$123.00 MIN ORDER: 1
WET FILTER WET FOAM FILTER SE 61 - SE 62 	7004 871 0101	\$143.00 MIN ORDER: 1	WET VACUUM SET SE 62 / 122 	4901 500 9400	\$148.00 MIN ORDER: 1
WET FILTER WET FOAM FILTER SE 122 	7004 871 0538	\$168.00 MIN ORDER: 1			
FILTER ELEMENT - STAINLESS STEEL WET STAINLESS STEEL FILTER - SE 62 / SE 122 	4901 501 0900	\$123.00 MIN ORDER: 1	BRUSH NOZZLE SE 33 / 62 / 122 / 133 M-E 	4901 502 2600	\$23.00 MIN ORDER: 1

#WEIGHT EXCLUDING CABLE



VACUUM CLEANER ACCESSORIES

	ORDER NUMBER	RRP INC. GST		ORDER NUMBER	RRP INC. GST
CLOTH BAG LOADING CLOTH - SE 122 	4774 703 5900	\$232.00 MIN ORDER: 1	RADIATOR NOZZLE SE 33/62/122 	4901 500 2600	\$12.00 MIN ORDER: 1
FILTER BAGS 5PK - SE 62 	4901 500 9004	\$34.00 MIN ORDER: 1	ADAPTER FOR POWER TOOLS (32MM) SE 62 While stocks last 	4901 503 1509	\$25.00 MIN ORDER: 1
FILTER BAGS 5PK - SE 122 	4901 500 9007	\$72.00 MIN ORDER: 1	ADAPTER FOR POWER TOOLS (36MM) SE 122/SE 133 M-E While stocks last 	4901 500 7301	\$28.00 MIN ORDER: 1
FILTER BAGS 5PK - SE 133 M-E 	4901 500 9009	\$77.00 MIN ORDER: 1			
CREVICE NOZZLE PLASTIC - SE 33/62/122/133 M-E 	4901 502 2200	\$12.00 MIN ORDER: 1	400MM PLASTIC FLOOR TOOL WET & DRY - SE 33/62/122 	4901 500 2705	\$113.00 MIN ORDER: 1
290MM PLASTIC FLOOR TOOL WET - SE 33/62/122 	4901 500 7200	\$36.00 MIN ORDER: 1	330MM ALLOY FLOOR TOOL DRY - SE 33/62/122/133 M-E 	4901 500 2700	\$113.00 MIN ORDER: 1
FLOOR TOOL SE 33/62/122 	4901 500 2503	\$103.00 MIN ORDER: 1	FLOOR NOZZLE BRUSH INSERT SE 33/62/122/133 M-E 	4901 500 2710	\$184.00 MIN ORDER: 1
FLOOR NOZZLE RUBBER INSERT WET & DRY - SE 33/62/122/133 M-E 	4901 500 2711	\$184.00 MIN ORDER: 1	UNIVERSAL NOZZLE PLASTIC SE 33/62/122 	4901 502 2300	\$12.00 MIN ORDER: 1
UNIVERSAL NOZZLE ALLOY SE 33/62/122 	4901 502 2310	\$61.00 MIN ORDER: 1	COARSE DIRT NOZZLE NO CONNECTOR SE 33/62/122/133 M-E 	4901 502 2705	\$12.00 MIN ORDER: 1
ANGLED NOZZLE RUBBER WET - SE 33/62/122/133 M-E 	4901 502 2400	\$21.00 MIN ORDER: 1	LONG CREVICE NOZZLE METAL SE 33/62/122/133 M-E 	4901 502 2201	\$72.00 MIN ORDER: 1
DUSTING BRUSH SE 33/62/122 	4901 502 2900	\$25.00 MIN ORDER: 1			





PETROL MISTBLOWER

		DISPLACEMENT (CM ³)	AIR THROUGHPUT (M ³ /H)	WEIGHT (KG)	ORDER NUMBER	MIN ORDER	RRP INC. GST
SR 450 BACKPACK		63.3	920**	12.8 [^]	4244 011 2602	1	\$1,199.00

PETROL MISTBLOWER ACCESSORIES

		ORDER NUMBER	RRP INC. GST		ORDER NUMBER	RRP INC. GST
HIP BELT SR 450		4203 710 9102	\$72.00 MIN ORDER: 1	PRESSURE KIT SR 450		4244 007 1004 \$367.00 MIN ORDER: 1
NOZZLE SET SR 450		4244 007 1022	\$19.00 MIN ORDER: 1			

MANUAL SPRAYERS

		WEIGHT (KG)	ORDER NUMBER	MIN ORDER	RRP INC. GST
SG 11 PLUS 1.5L		0.48	4255 019 4912	6	\$36.00
SG 21 3.0L		1.2	4255 019 4921	1	\$56.00
SG 31 5.0L		1.3	4255 019 4930	1	\$72.00
SG 51 BACKPACK 12.0L		4.5	4255 019 4950	1	\$184.00
SG 71 BACKPACK 18.0L		4.8	4255 019 4970	1	\$235.00

i SEE PAGE 13 FOR BATTERY SPRAYER SGA 85



Order number

Displacement (cm³)

Container capacity (l)

Weight (kg)Ⓚ

Sound pressure level② (dB(A))

Sound power level② (dB(A))

Vibration level③ (m/s⁴)

STIHL engine (2-MIX/4-MIX)

Max. air throughput (m³/h)④

Max. horizontal range (m)

STIHL anti-vibration system

STIHL ElastoStart

Long-life air filter system

Dusting function

One-handed multi-function handle

MISTBLOWER

SR 450	4244 011 2602	63.3	14	12.8	102	109	19	2-MIX	1,300	14.5	●	●	●	●	●
--------	---------------	------	----	------	-----	-----	----	-------	-------	------	---	---	---	---	---















*WEIGHT EXCLUDING FUEL, FULLY ASSEMBLED
**WITH BLOWER ATTACHMENT
● AS STANDARD

① WEIGHT EXCLUDING FUEL, FULLY ASSEMBLED
② K FACTOR ACCORDING TO DIR. 2006/42/EC = 1.5 dB(A)

③ K FACTOR ACCORDING TO DIR. 2006/42/EC = 2 M/S²
④ EXCLUDING BLOWER ATTACHMENT

⑤ ALL LOCAL REGULATIONS MUST BE FOLLOWED WHEN USING MISTBLOWER

MANUAL SPRAYER ACCESSORIES

	ORDER NUMBER	RRP INC. GST		ORDER NUMBER	RRP INC. GST
EXTENSION TUBE 150MM SG 10/11 	4247 500 0301	\$25.00 MIN ORDER: 1	NOZZLE SET SG 20 - 71 	4255 007 1000	\$44.00 MIN ORDER: 1
EXTENSION TUBE 400MM SG 31 - 71 	4255 500 0300	\$23.00 MIN ORDER: 1	WIDE BRASS SPRAY BAR 100CM - SG 51/71 	4255 500 9702	\$184.00 MIN ORDER: 1
TELESCOPIC TUBE 520 900MM SG 21 - 71 	4255 500 0900	\$47.00 MIN ORDER: 1	FAN JET BRASS NOZZLE SG 21 - 71 / 80 - 04 	4255 502 1700	\$25.00 MIN ORDER: 1
SPRAY GUARD SG 20 While stocks last 	4247 500 5801	\$72.00 MIN ORDER: 1	FINE FILTER 100 MICRONS - SG 51/71 	4255 502 0701	\$12.00 MIN ORDER: 1
SPRAY GUARD SG 21 - 71 	4255 500 5800	\$72.00 MIN ORDER: 1	ADJUSTABLE BRASS NOZZLE SG 21 - 71 	4255 700 6302	\$27.00 MIN ORDER: 1
SPLIT NOZZLE SG 31 - 71 	4255 500 8500	\$67.00 MIN ORDER: 1	SPRAYER NOZZLE HOLDER SG 21 - 71 	4255 500 2800	\$12.00 MIN ORDER: 1
FAN JET BRASS NOZZLE SG 21-71/65-0025 	4255 502 1701	\$36.00 MIN ORDER: 1	HOLLOW BRASS CONE NOZZLE 2.5MM SG 21-71 	4255 700 6303	\$14.00 MIN ORDER: 1

MANUAL SWEEPERS

	SWEeping WIDTH (CM)	CONTAINER VOLUME (L)	WEIGHT (KG)	ORDER NUMBER	MIN ORDER	RRP INC. GST
 <p>KG 770</p>	77	50	13.0	4860 019 4707	1	\$899.00

BATTERY SWEEPER

	SWEeping WIDTH (CM)	CONTAINER VOLUME (L)	WEIGHT (KG)	ORDER NUMBER	MIN ORDER	RRP INC. GST
  <p>KGA 770 SKIN</p>	77	50	16.0*	4860 011 4704	1	\$1,399.00

Order number

Container capacity (l)

Sweep width (cm)

Rated voltage (V)

Weight (kg)

Sound pressure level^① (dB(A))

Sound power level^② (dB(A))

For areas up to ... (m²)

Sweeping concept

Central height adjustment

Protective cover for the long-life transmission

All-round sealing + air filter

Bristle hold-down clamp

Ergonomically designed push bar

Battery operation (for circular brushes / power sweeper)

Indoor areas: interlocking paving stones / sealed floors

Outside areas: asphalt / exposed aggregate concrete / interlocking paving stones / cobblestones

SWEEPERS																	
KG 770	4860 019 4706	50	77	-	13.0	-	-	1,500	MultiClean PLUS	●	●	●	●	●	-/-	●/●	●/●/●/●
BATTERY SWEEPER																	
KGA 770	4860 011 4704	50	77	36	16.0 ^①	64	80	2,000	MultiClean PLUS	●	●	●	●	●	●/●	●/●	●/●/●/●

*WEIGHT EXCLUDING BATTERY

① WEIGHT EXCLUDING BATTERY

② K FACTOR ACCORDING TO DIR. 2006/42/EC = 2.5 dB(A)



PETROL DRILL

	DISPLACEMENT (CM ³)	POWER OUTPUT (W)	WEIGHT (KG)	ORDER NUMBER	MIN ORDER	RRP INC. GST
BT 45 Wood drill sold separately 	27.2	0.8/1.1	4.8 [^]	4314 200 0025	1	\$899.00**









DRILL BITS (SUITS BT 45)

	SIZE	ORDER NUMBER	MIN ORDER	RRP INC. GST
WOOD DRILL BITS BT 45 	13MM/1/2" X 320MM	4314 682 5001	1	\$82.00
	19MM/3/4" X 460MM	4314 682 5002	1	\$87.00
	22MM/7/8" X 460MM	4314 682 5003	1	\$128.00
	25MM/1" X 460MM	4314 682 5004	1	\$138.00

PLANTING AUGERS (SUITS BT 45)

	ORDER NUMBER	RRP INC. GST		ORDER NUMBER	RRP INC. GST
76MM/3" X 590MM BT 45 	4314 680 1903	\$230.00 MIN ORDER: 1	127MM/5" X 590MM BT 45 	4314 680 1905	\$256.00 MIN ORDER: 1
100MM/4" X 590MM BT 45 	4314 680 1904	\$240.00 MIN ORDER: 1			

PETROL DRILL ACCESSORIES (SUITS BT 45)

	ORDER NUMBER	RRP INC. GST		ORDER NUMBER	RRP INC. GST
WATER ATTACHMENT SET BT 45 	4314 007 1005	\$536.00 MIN ORDER: 1	BELT STRAP BT 45 	4314 710 6500	\$16.00 MIN ORDER: 1
WATER ATTACHMENT ADAPTER 1/4" BT 45 	4314 682 3904	\$113.00 MIN ORDER: 1	CARRY HANDLE BT 45 	4314 710 9000	\$30.00 MIN ORDER: 1
WATER ATTACHMENT ADAPTER 5/8" BT 45 	4314 682 3903	\$67.00 MIN ORDER: 1			
ADAPTOR - DRILLING PLANTING HOLES BT 45 	4314 682 3900	\$18.00 MIN ORDER: 1	DRILL CHUCK WITH KEY BT 45 	4314 680 4001	\$169.00 MIN ORDER: 1
CONVERSION KIT BT 45 	DRILLING PLANTING HOLES		4314 007 1001	\$169.00 MIN ORDER: 1	
	TOOLESS WOOD DRILLING (NOT PICTURED)		4314 007 1000	\$184.00 MIN ORDER: 1	
	WOOD DRILLING WITH KEY (NOT PICTURED)		4314 007 1004	\$235.00 MIN ORDER: 1	

*WEIGHT EXCLUDING FUEL, FULLY ASSEMBLED

**PRICE EXCLUDES DRILLING TOOL

PETROL AUGER



DISPLACEMENT (CM ³)	POWER OUTPUT (KW/HP)	WEIGHT (KG)	ORDER NUMBER	MIN ORDER	RRP INC. GST
---------------------------------	----------------------	-------------	--------------	-----------	--------------

BT 131
Auger bit sold separately

36.3 1.4/1.9 10.0* **4313 011 2124** 1 **\$1,649.00***

AUGERS & ACCESSORIES (SUITS BT 131)

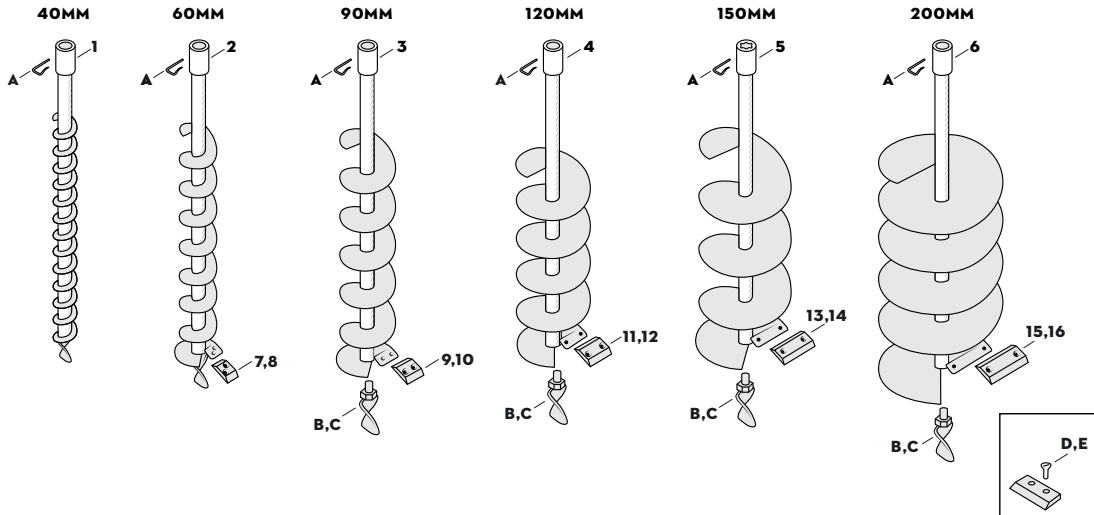



REFERENCE	ORDER NUMBER	MIN ORDER	RRP INC. GST
-----------	--------------	-----------	--------------



40MM/1 9/16" X 695MM AUGER ASSEMBLY COMPLETE		1	4404 680 2004	1	\$327.00
60MM/2 3/8" X 695MM AUGER ASSEMBLY COMPLETE		2	4404 680 2006	1	\$475.00
90MM/4" X 695MM AUGER ASSEMBLY COMPLETE		3	4404 680 2009	1	\$490.00
120MM/5" X 695MM AUGER ASSEMBLY COMPLETE		4	4404 680 2012	1	\$511.00
150MM/6" X 695MM AUGER ASSEMBLY COMPLETE		5	4404 680 2015	1	\$546.00
200MM/8" X 695MM AUGER ASSEMBLY COMPLETE		6	4404 680 2020	1	\$582.00
60MM/2 3/8" PLAIN BLADE TIP		7	4404 682 3101	1	\$44.00
60MM/2 3/8" TUNGSTEN BLADE TIP		8	7004 871 0113	1	\$138.00
90MM/4" PLAIN BLADE TIP		9	4404 682 3102	1	\$44.00
90MM/4" TUNGSTEN BLADE TIP		10	7004 871 0114	1	\$148.00
120MM/5" PLAIN BLADE TIP		11	4404 682 3103	1	\$44.00
120MM/5" TUNGSTEN BLADE TIP		12	7004 871 0115	1	\$153.00
150MM/6" PLAIN BLADE TIP		13	4404 682 3104	1	\$44.00
150MM/6" TUNGSTEN BLADE TIP		14	7004 871 0116	1	\$164.00
200MM/8" PLAIN BLADE TIP		15	4404 682 3105	1	\$44.00
200MM/8" TUNGSTEN BLADE TIP		16	7004 871 0117	1	\$169.00



*WEIGHT EXCLUDING FUEL & DRILL BIT



*PRICE EXCLUDES DRILLING TOOL

AUGERS AND ACCESSORIES CONTINUED (SUITS BT 131)

	REFERENCE	ORDER NUMBER	MIN ORDER	RRP INC. GST
HEAVY DUTY AUGER RETAINING CLIP 	A	7004 871 0544	1	\$10.00
THREADED PILOT BIT Suits 90mm - 200mm Augers 	B	7004 871 0543	1	\$87.00
THREADED TUNGSTEN Y-PILOT BIT Suits 90mm - 200mm Augers 	C	7004 871 0541	1	\$153.00
BOLT 6MM Use with 60mm - 150mm Augers - Pack of 2 Bolts	D	7004 871 0619	1	\$1.00
BOLT 8MM Use with 200mm Auger only - Pack of 2 Bolts	E	7004 871 0620	1	\$1.00

SOIL LOOSENER / PLANTING AUGER BIT		DRILL CHUCK	
ORDER NUMBER	RRP INC. GST	ORDER NUMBER	RRP INC. GST
250MM/10" X 660MM BT 131 	4404 680 1900 \$490.00 MIN ORDER: 1	UP TO 13MM BT 131 	4311 680 4010 \$306.00 MIN ORDER: 1

PLANTING AUGERS		REPLACEMENT CUSHION	
ORDER NUMBER	RRP INC. GST	ORDER NUMBER	RRP INC. GST
150MM/6" X 525MM BT 131 	4311 680 2515 \$449.00 MIN ORDER: 1	BT 131 	4313 748 2501 \$74.00 MIN ORDER: 1

SHAFT EXTENSION		DRILL POINTS FOR AUGERS	
ORDER NUMBER	RRP INC. GST	ORDER NUMBER	RRP INC. GST
SHAFT EXTENSION 450MM BT 131 	4311 680 2350 \$159.00 MIN ORDER: 1	TCT FINGER SCRIBE WITH NUTS & BOLTS BT 131 	7004 871 0542 \$123.00 MIN ORDER: 1

AUGERS AND ACCESSORIES (SUITS BT 360)

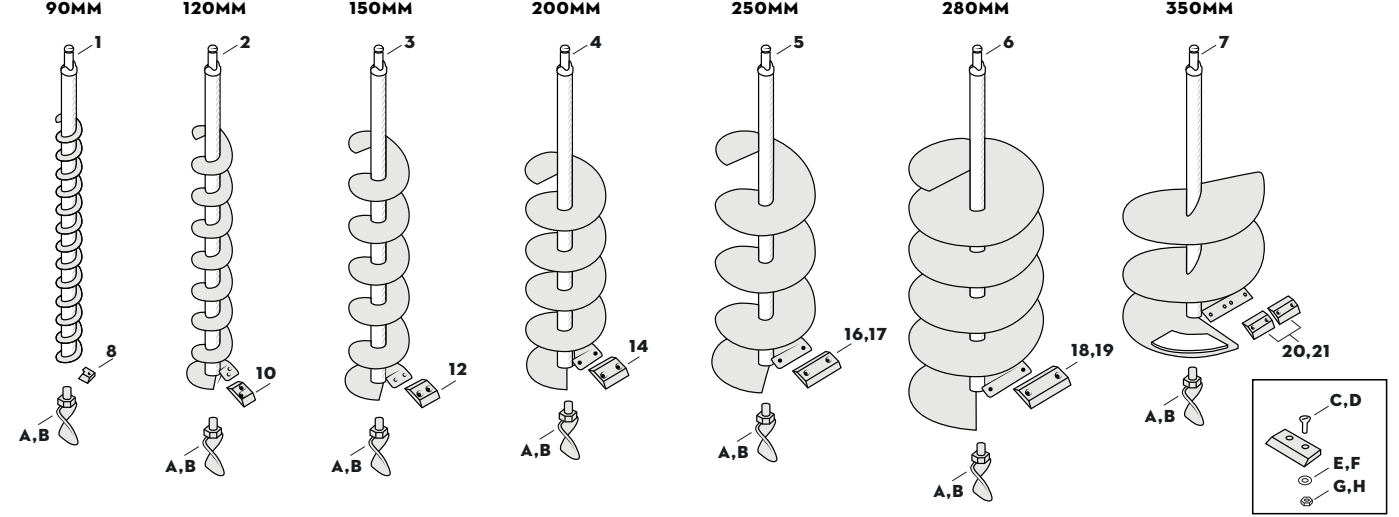

AUGERS AND ACCESSORIES CONTINUED (SUITS BT 360)

	REFERENCE	ORDER NUMBER	MIN ORDER	RRP INC. GST
90MM/4" X 700MM AUGER ASSEMBLY COMPLETE	1	4400 000 4209	1	\$725.00
120MM/5" X 700MM AUGER ASSEMBLY COMPLETE	2	4400 000 4212	1	\$745.00
150MM/6" X 700MM AUGER ASSEMBLY COMPLETE	3	4400 000 4215	1	\$755.00
200MM/8" X 700MM AUGER ASSEMBLY COMPLETE	4	4400 000 4220	1	\$791.00
250MM/10" X 700MM AUGER ASSEMBLY COMPLETE	5	4400 000 4225	1	\$837.00
280MM/12" X 700MM AUGER ASSEMBLY COMPLETE	6	4400 000 4228	1	\$847.00
350MM/14" X 700MM AUGER ASSEMBLY COMPLETE	7	4400 000 4235	1	\$924.00
90MM/4" PLAIN BLADE TIP	8	4402 682 3100	1	\$44.00
120MM/5" PLAIN BLADE TIP	10	4402 682 3105	1	\$38.00
150MM/6" PLAIN BLADE TIP	12	4402 682 3110	1	\$44.00
200MM/8" PLAIN BLADE TIP	14	4402 682 3120	1	\$50.00
250MM/10" PLAIN BLADE TIP	16	4402 682 3130	1	\$54.00
250MM/10" TUNGSTEN BLADE TIP	17	7004 871 0110	1	\$235.00
280MM/12" PLAIN BLADE TIP	18	4402 682 3135	1	\$56.00
280MM/12" TUNGSTEN BLADE TIP	19	7004 871 0111	1	\$276.00
350MM/14" PLAIN BLADE TIP	20	4402 682 3140	1	\$61.00
350MM/14" TUNGSTEN BLADE TIP	21	7004 871 0112	1	\$322.00



AUGER ACCESSORIES (SUITS BT 360)

	REFERENCE	ORDER NUMBER	MIN ORDER	RRP INC. GST
THREADED POINT PLAIN	A	4401 680 3300	1	\$215.00
THREADED POINT TUNGSTEN	B	7004 871 0105	1	\$327.00
BOLT 8MM Use with 90mm - 280mm Augers	C	9057 068 1830	1	\$3.00
BOLT 10MM Use with 350mm Auger only	D	9057 068 2390	1	\$3.00
WASHER 8MM Use with 90mm - 280mm Augers	E	9291 021 0180	1	\$1.00
WASHER 10MM Use with 350mm Auger only	F	9291 021 0200	1	\$1.00
NUT 8MM Use with 90mm - 280mm Augers	G	9210 260 1100	1	\$2.00
NUT 10MM Use with 350mm Auger only	H	9210 260 1300	1	\$2.00

SHAFT EXTENSIONS (SUITS BT 360)

	ORDER NUMBER	MIN ORDER	RRP INC. GST
500MM - BT 360	4470 000 4205	1	\$240.00
1000MM - BT 360	4470 000 4210	1	\$419.00
SHANK END Ø 250 - 350 MM / 10 - 14" - BT 360	4401 682 1010	1	\$278.00

AUGER IDENTIFICATION

Augers suitable for use with BT 131 and BT 360 can be easily identified by the way they attach to the head

BT 131 AUGERS ATTACH VIA A SPLINE WITH A HEAVY DUTY RETAINER CLIP



BT 360 AUGERS ATTACH VIA A SHANK WITH LOCATING TABS



Order number

Displacement (cm³)

Power output (kW/hp)

Weight (kg)^①

Sound pressure level^② (dB(A))

Sound power level^② (dB(A))

Vibration level, left/right^③ (m/s²)

STIHL engine (2-MIX/4-MIX)

Spindle speed (rpm)

Spindle speed second gear (rpm)

Spindle speed reverse gear (rpm)

Automatic decompression valve

STIHL ElastoStart

Long-life air filter system

QuickStop drill brake

Start lock/reverse rotation lock

AUGER[®]

BT 131[®]	4313 011 2124	36.3	1.4/1.9	10.0	92	100	1.7/2.0	4-MIX	200	-	-	●	-	●	●	●
BT 45	4314 200 0025	27.2	0.8/1.1	4.8	98	103	7.2/6.1	-	910	2,710	810	-	-	-	-	-

● AS STANDARD

① WEIGHT EXCLUDING FUEL & DRILL BIT

② K FACTOR ACCORDING TO DIR. 2006/42/EC = 2.5 dB(A)

③ K FACTOR ACCORDING TO DIR. 2006/42/EC = 2 M/S²

④ DELIVERY WITHOUT DRILL BIT

⑤ WITH SUPPORT CUSHION

PETROL CUT-OFF CHAINSAW

	BAR LENGTH (CM/INCH)	DISPLACEMENT (CM ³)	POWER OUTPUT (KW/HP)	WEIGHT (KG)	ORDER NUMBER	MIN ORDER	RRP INC. GST
 <p>GS 461 40CM/16"</p>	40/16	76.5	4.3/5.8	7.6 ^{^^}	4252 200 0060	1	\$2,999.00

i NOTE: THE GS 461 KIT IS NOW BEING SUPPLIED WITH NEW BAR & CHAIN. NEW GUIDE BAR 3006 000 1513 IS SUITABLE FOR BOTH CURRENT (3213 & 3214) CHAINS. GUIDE BAR 3006 000 1213 IS ONLY SUITABLE FOR PREVIOUS (3210 & 3211) CHAINS.

DIAMOND CONCRETE CUTTER CHAIN

	DESCRIPTION	ORDER NUMBER	CASE QTY	MIN ORDER	RRP INC. GST
 <p>36GBE</p>	40CM/16" INC SPROCKET	3214 000 0064	20	1	\$281.00
 <p>36GBM</p>	40CM/16" INC SPROCKET	3213 000 0064	20	1	\$766.00

NOTE: GBM - good for harsh and abrasive environments - has a tooth on every link - not good for use in soft conditions as rivets will wear out before teeth - not economically viable in these conditions.

GBM good for: Concrete - reinforced concrete - bricks in general - masonry - stoneware pipes - abrasive rock* such as asphalt and building blocks (sandstone) - hard rock, granite*

GBE - Better for use in soft conditions - is a skip chain design to keep cost lower, with less teeth they will wear at same rate as tie straps and rivets. GBE is particularly suitable for cutting the following material:
 - Abrasive stone, e. g. asphalt and bricks (sandstone) Moreover, the following materials can also be cut:
 - Concrete - Reinforced concrete - General blocks

*Reductions in performance and service life possible

ROLLOMATIC G GUIDE BAR

	DESCRIPTION	ORDER NUMBER	MIN ORDER	RRP INC. GST
 <p>ROLLOMATIC G</p>	40CM/16"	3006 000 1513	1	\$230.00

i IMPORTANT: NEW GUIDE BAR 3006 000 1513 IS SUITABLE FOR BOTH CURRENT (3210 & 3213) CHAINS.

GUIDE CLAW

	SUITABLE FOR:	ORDER NUMBER	MIN ORDER	RRP INC. GST
 <p>GS</p>	GS 461	4252 660 0900	1	\$103.00

Order number

Rolromatic G guide bar (bar length, cm)^②

Displacement (cm³)

Power output (kW/hp)

Weight (kg)^④

Sound pressure level^③ (dB(A))

Sound power level^③ (dB(A))

Vibration level, left/right^③ (m/s²)

STIHL engine (2-MIX / 4-MIX)

Saw chain pitch

STIHL diamond concrete cutter chain

Side-mounted chain tensioning

Decompression valve

STIHL anti-vibration system

STIHL ElastoStart

HD2 filter

Tool-free fuel cap

Water connection

Wear-resistant starter cord

CONCRETE SAW

GS 461	4252 200 0060	40	76.5	4.3/5.8	7.6	105	115	4.5/4.0	2-MIX	3/8"	GBM	●	●	●	●	●	●	●	●
--------	---------------	----	------	---------	-----	-----	-----	---------	-------	------	-----	---	---	---	---	---	---	---	---

● AS STANDARD

② THE ACTUAL BAR LENGTH IS SHORTER THAN THE BAR LENGTH STATED
 ③ WEIGHT EXCLUDING FUEL, GUIDE BAR OR DIAMOND CONCRETE CUTTER CHAIN
 ④ K FACTOR ACCORDING TO DIR. 2006/42/EC = 2.5 dB(A)

⑤ K FACTOR ACCORDING TO DIR. 2006/42/EC = 2 M/S²
 **WEIGHT EXCLUDING FUEL, GUIDE BAR & DIAMOND CONCRETE CUTTER CHAIN

PETROL CUT-OFF MACHINES







		DISPLACEMENT (CM ³)	POWER OUTPUT (KW / HP)	WEIGHT (KG)	ORDER NUMBER	MIN ORDER	RRP INC. GST
TS 420 350MM/14"		66.7	3.2/4.4	9.6 [^]	4238 011 2808	1	\$1,599.00[#]
TS 440 350MM/14" Available to TS 440 qualified dealers only		66.7	3.2/4.4	11.1 [^]	4238 011 2809	1	\$2,199.00[#]
TS 500i 350MM/14"		72.2	3.9/5.3	10.2 [^]	4250 011 2808	1	\$1,799.00[#]
TS 710i 350MM/14"		92	5.2 / 6.9	12.2 [^]	TB01 011 2804	1	\$2,399.00[#]
TS 910i 400MM/418MM /16"		102	6.2 / 8.3	12.8 [^]	TB01 011 2824	1	\$2,599.00[#]

NOTE: TS & TSA machines are not supplied with a diamond wheel as standard fitment. They are supplied with an abrasive wheel as standard.

Order number	Displacement (cm ³)	Power output (kW/hp)	Rated voltage (V)	Weight (kg)	Sound pressure level ^① (dB(A))	Sound power level ^② (dB(A))	Vibration level left/right ^③ (m/s ²)	STIHL engine (2-MIX/4-MIX)	Total length (cm)	Cutting wheel (mm)	Max. cutting depth (mm)	Decompression valve	STIHL anti-vibration system	STIHL ElastoStart	Water connection	Wear-resistant starter cord	Magnesium guard	Electronic water control	Semi-automatic belt tensioning	Cyclone air routing	STIHL Injection (i)	STIHL QuickStop cutting brake
PETROL CUT-OFF MACHINES																						
TS 420	4238 011 2808	66.7	3.2/4.4	-	97 ^④	98 ^⑤	39/39	2-MIX	72	350	125	●	●	○	●	●	●	-	●	●	-	-
TS 440	4238 011 2809	66.7	3.2/4.4	-	111 ^④	98 ^⑤	39/39	2-MIX	72.7	350	125	●	●	○	●	●	●	●	●	●	-	●
TS 500i	4250 011 2808	72.2	3.9/5.3	-	102 ^④	98 ^⑤	2.4/2.0	2-MIX	73.0	350	125	●	●	●	●	●	●	●	●	●	●	-
TSA 710i	TB01 011 2804	92	5.2 / 6.9	-	122 ^④	105 ^⑤	70 / 50	2-MIX	81.8	350	125	●	●	●	●	●	●	-	●	●	●	-
TSA 910i	TB01 011 2824	102	6.2 / 8.3	-	128 ^④	108 ^⑤	70 / 50	2-MIX	86.7	400 418MM	145 150MM	●	●	●	●	●	●	-	●	●	●	-
BATTERY CUT-OFF MACHINE																						
TSA 230	4864 011 6620	-	-	36	39 ^④	103 ^⑤	3.5/3.5	-	55.0	230	70	-	-	-	●	-	●	-	-	-	-	-
TSA 300	TA02 011 6606	-	-	36	63 ^④	105 ^⑤	2.3 / 3.0	-	-	300	110	-	-	-	●	-	●	-	-	-	-	-

*WEIGHT EXCLUDING BATTERY & CUTTING WHEEL
 #WEIGHT EXCLUDING FUEL & CUTTING WHEEL
 #PRICE EXCLUDING DIAMOND CUTTING WHEELS
 ● AS STANDARD
 ○ RETROFITTABLE (ACCESSORY)
 A = ELECTRONIC WATER CONTROL
 i = STIHL INJECTION
 ① K FACTOR ACCORDING TO DIR. 2006/42/EC = 2.5 dB(A)
 ② K FACTOR ACCORDING TO DIR. 2006/42/EC = 2 M/S²
 ③ WITH ABRASIVE CUTTING WHEEL
 ④ WEIGHT EXCLUDING FUEL & CUTTING WHEEL
 ⑤ WEIGHT EXCLUDING BATTERY & CUTTING WHEEL
 ⑥ MEASUREMENT ACCORDING TO ISO 19432
 ⑦ MEASUREMENT WITH CUTTING WHEELS ACCORDING TO EN 60745-2-22

CUT-OFF MACHINE CARTS

		SUITABLE FOR:	ORDER NUMBER	MIN ORDER	RRP INC. GST
REINFORCED PULLEY GUARD		TS 910i	TB01 700 8107	1	\$149.00
FW 20 Includes Mounting Kit & Water Tank TS 440 cannot be used with FW 20 cart		TS 420 / 500i	7004 200 0005	1	\$1,474.00
		TS 700 / 800	7004 200 0008	1	\$1,474.00
		TS 710i / 910i	4224 200 0056	1	\$1,474.00
FW 20 Mounting Kit suits select petrol cut-off machines		TS 420 / 500i	4250 790 0702	1	\$363.00
		TS 700 / 800	4224 790 0705	1	\$363.00
		TS 710i / 910i	TB01 790 0702	1	\$363.00
FW 20 Cutting Direction Kit		FITS FW TROLLEY	4205 007 1009	1	\$113.00
TS Wheel Mounting Kit		SUITS ALL CUT-OFF MACHINES	4224 007 1014	1	\$113.00
WATER TANK & MOUNTING KIT See SSC for further info		FW 20 CART	4224 007 1009	1	\$256.00
LOW PROFILE WATER TANK & MOUNTING KIT See SSC for further info		FW 20 CART	4224 007 1018	1	\$240.00

PRESSURISED WATER BOTTLE





		DESCRIPTION	ORDER NUMBER	MIN ORDER	RRP INC. GST
CUT-OFF MACHINE WATER BOTTLE *Not suitable for GS 461		10L	0000 670 6000	1	\$256.00











DIAMOND CUTTING WHEELS

	DESCRIPTION	ORDER NUMBER	MIN ORDER	RRP INC. GST
	DIAMOND WHEEL - B10 230MM - ID 22.23MM	0835 090 7050	1	\$87.00
	DIAMOND WHEEL - B10 300MM - ID 20MM	0835 090 7051	1	\$89.00
	DIAMOND WHEEL - B10 350MM - ID 20MM	0835 090 7052	1	\$95.00
	DIAMOND WHEEL - B10 400MM - ID 20MM	0835 090 7053	1	\$195.00
	DIAMOND WHEEL - B20 350MM - ID 20MM	0835 090 7054	1	\$165.00
	DIAMOND WHEEL - B20 400MM - ID 20MM	0835 090 7055	1	\$265.00
	DIAMOND WHEEL - BA10 300MM - ID 20MM	0835 094 7006	1	\$129.00
	DIAMOND WHEEL - SB80 230MM - ID 22.23MM	0835 096 7007	1	\$189.00
	DIAMOND WHEEL - SB90 350MM - ID 20MM (Recommended for use with TS 440)	0835 096 7005	1	\$275.00
	DIAMOND WHEEL - SB80N 230MM - ID 22.23MM	0835 097 7000	1	\$219.00
	DIAMOND WHEEL - SB90 300MM - ID 20MM	0835 096 7004	1	\$199.00
	DIAMOND WHEEL - SB90N 300MM - ID 20MM	0835 097 7001	1	\$275.00
	DIAMOND WHEEL - BA90 X 350MM - ID 20MM	0835 094 7013	1	\$275.00
	DIAMOND WHEEL - BA90 400MM - ID 20MM	0835 094 7014	1	\$375.00
	DIAMOND WHEEL - BA90 418MM - ID 20MM	0835 094 7015	1	\$375.00
	DIAMOND CUTTING WHEEL - G80 300MM - 20MM	0835 070 7002	1	\$329.00
	DIAMOND CUTTING WHEEL - G80 350MM - 20MM (Recommended for use with TS 440)	0835 070 7000	1	\$390.00

COMPOSITE RESIN CUTTING WHEELS









	DESCRIPTION	ORDER NUMBER	MIN ORDER	RRP INC. GST
	ABRASIVE WHEEL - STEEL 230MM - ID 22.23MM	0835 012 7000	10	\$11.00
	ABRASIVE WHEEL - STEEL 300MM - ID 20MM	0835 010 7000	10	\$19.00
	ABRASIVE WHEEL - STONE 300MM - ID 20MM	0835 020 7000	10	\$19.00
	ABRASIVE WHEEL - ASPHALT 300MM - ID 20MM	0835 030 7000	10	\$19.00
	ABRASIVE WHEEL - STONE 350MM - ID 20MM	0835 020 7001	10	\$15.00
	ABRASIVE WHEEL - STONE 400MM - ID 20MM	0835 020 7002	10	\$20.00
	ABRASIVE WHEEL - ASPHALT 350MM - ID 20MM	0835 030 7001	10	\$15.00
	ABRASIVE WHEEL - ASPHALT 400MM - ID 20MM	0835 030 7002	10	\$20.00
	ABRASIVE WHEEL - STEEL 350MM - ID 20MM	0835 010 7001	10	\$15.00
	ABRASIVE WHEEL - STEEL 400MM - ID 20MM	0835 010 7006	10	\$20.00
	ABRASIVE WHEEL - STEEL 350MM - ID 20MM (Use only with TS 440)	0835 012 7001	10	\$15.00

Order number	Diameter (mm)	Asphalt 	Brick, concrete 	Ductile cast iron 	Structural steel 	Stainless steel 
COMPOSITE RESIN CUTTING WHEELS		RECOMMENDED USE^①				
K-ME						
0835 012 7000	230	-	-	-	•	•
0835 010 7000	300	-	-	-	•	-
0835 010 7001	350					
0835 012 7001 <small>TS 440 suitable</small>	350					
0835 010 7006	400					
K-DG						
0835 030 7000	300	•	-	•	-	-
0835 030 7001	350					
0835 030 7002	400					
K-BA						
0835 020 7000	300	-	•	-	-	-
0835 020 7001	350					
0835 020 7002	400					

Order number	Diameter (mm)	Asphalt 	Fresh concrete 	Sandstone 	Brick 	Concrete 	Reinforced concrete 	Strongly reinforced concrete, old concrete 	Structural steel 	Granite, hard natural stone 	Ductile cast pipes, plug-in pipes (polyurethane, polypropylene, PVC) 	Reduced noise levels 
DIAMOND CUTTING WHEELS		RECOMMENDED USE^①										
FOR GENERAL CONSTRUCTION USE												
D-B10	0835 090 7050	230	-	-	-	•	•	•	-	-	-	-
Service life	0835 090 7051	300										
Cutting performance	0835 090 7052	350										
	0835 090 7053	400										
D-B20	0835 090 7054	350	-	-	-	•	•	•	-	-	-	-
Service life	0835 090 7055	400										
Cutting performance												
FOR ALL-PURPOSE USE												
D-BA10	0835 094 7006	300	•	•	•	•	•	•	-	-	-	-
Service life												
Cutting performance												
D-BA90	0835 094 7013	350	•	•	•	•	•	•	-	-	-	-
Service life	0835 094 7014	400										
Cutting performance	0835 094 7015	418										
FOR HEAVY-DUTY AND SPECIAL USES												
D-SB80	0835 096 7007	230	-	-	-	•	•	•	•	-	•	-
Service life												
Cutting performance												
D-SB90	0835 096 7004	300	-	-	-	•	•	•	•	-	•	-
Service life	0835 096 7005	350										
Cutting performance												
D-G80	0835 070 7002	300	-	-	-	-	-	-	•	-	•	-
Service life	0835 070 7000	350										
Cutting performance												
FOR USE WITH BATTERY CUT-OFF MACHINES												
NEW D-SB80N	0835 097 7000	230	-	-	-	•	•	•	•	-	•	•
Service life												
Cutting performance												
D-SB90N	0835 097 7001	300	-	-	-	•	•	•	•	-	•	•
Service life												
Cutting performance												







- Suitable
- Not recommended

① When selecting cutting wheels, you need to consider the intended application as well as which cut-off machine you have.
Note: All STIHL cut-off machines are delivered with a composite resin cutting wheel for structural steel and stainless steel



SERVICE KITS		PART COMPONENTS	ORDER NUMBER	CASE QTY	MIN ORDER	RRP INC. GST
<p>SERVICE KIT MS 162 / MS 172 / MS 172 C-BE</p> 	<p>AIR FILTER FUEL FILTER SPARK PLUG</p>	1148 007 4100	5	1	\$19.00	
<p>SERVICE KIT MS 182 / MS 182 C-BE / MS 212 / MS 212 C-BE</p> 	<p>AIR FILTER FUEL FILTER SPARK PLUG</p>	1148 007 4101	5	1	\$33.00	
<p>SERVICE KIT MS 170 / MS 180</p> 	<p>AIR FILTER FUEL FILTER SPARK PLUG</p>	1130 007 4101	5	1	\$21.00	
<p>SERVICE KIT MS 171 / MS 181 / MS 211</p> 	<p>AIR FILTER FUEL FILTER SPARK PLUG</p>	1139 007 4100	12	1	\$44.00	
<p>SERVICE KIT MS 362 / 400</p> 	<p>AIR FILTER FUEL FILTER SPARK PLUG (MS 362 serial number > 183717483)</p>	1140 007 4102	5	1	\$43.00	
<p>SERVICE KIT MS 462</p> 	<p>AIR FILTER FUEL FILTER SPARK PLUG</p>	1142 007 4101	5	1	\$45.00	
<p>SERVICE KIT MS 500i</p> 	<p>AIR FILTER FUEL FILTER SPARK PLUG</p>	1147 007 4101	5	1	\$47.00	
<p>SERVICE KIT MS 660 / 880</p> 	<p>AIR FILTER FUEL FILTER SPARK PLUG</p>	1124 007 4101	5	1	\$56.00	

SERVICE KITS



		PART COMPONENTS	ORDER NUMBER	CASE QTY	MIN ORDER	RRP INC. GST
SERVICE KIT MS 661		AIR FILTER FUEL FILTER SPARK PLUG	1144 007 4101	5	1	\$45.00
SERVICE KIT MS 881		AIR FILTER FUEL FILTER SPARK PLUG	1124 007 4102	5	1	\$56.00
SERVICE KIT FS 38 / FS 45 / FS 55		AIR FILTER FUEL FILTER SPARK PLUG	4140 007 4100	12	1	\$20.00
SERVICE KIT FS 70 R / HT 56 / KM 56 RC-E		AIR FILTER FUEL FILTER SPARK PLUG	4144 007 4100	12	1	\$21.00
SERVICE KIT FS 91 / FS 111 / HT 103 / HT 105		AIR FILTER FUEL FILTER SPARK PLUG	4180 007 4102	12	1	\$35.00
SERVICE KIT FS 131 / KM 131 R / BT 131 / HT 133 / HT 135		AIR FILTER FUEL FILTER SPARK PLUG	4180 007 4103	12	1	\$35.00
SERVICE KIT HS 45		AIR FILTER FUEL FILTER SPARK PLUG	4140 007 4101	5	1	\$20.00
SERVICE KIT TS 420 / 440		AIR FILTER FUEL FILTER SPARK PLUG	4238 007 4102	5	1	\$66.00

SERVICE KITS		PART COMPONENTS	ORDER NUMBER	CASE QTY	MIN ORDER	RRP INC. GST
SERVICE KIT TS 700/800		AIR FILTER FUEL FILTER SPARK PLUG PRE FILTER	4224 007 4100	5	1	\$90.00
SERVICE KIT TS 710i / 910i		AIR FILTER FUEL FILTER SPARK PLUG PRE FILTER	TB01 007 4100	5	1	\$66.00
SERVICE KIT BG 86 / SH 86 / BG 56 / SH 56		AIR FILTER FUEL FILTER SPARK PLUG (BG 86 serial number > 290871694, SH 86 serial number > 291051831)	4241 007 4101	5	1	\$44.00
SERVICE KIT BR 350 / BR 450 / SR 450		AIR FILTER FUEL FILTER SPARK PLUG	4244 007 1800	8	1	\$57.00
SERVICE KIT BR 700		AIR FILTER FUEL FILTER SPARK PLUG	4282 007 4100	8	1	\$65.00
SERVICE KIT BR 800		AIR FILTER FUEL FILTER SPARK PLUG	4283 007 4101	5	1	\$39.00

SMART CONNECT

	ORDER NUMBER	RRP INC. GST		ORDER NUMBER	RRP INC. GST		
SMART CONNECTOR		0000 400 4900 MIN ORDER: 1	\$46.00	SMART CONNECTOR 10 PACK		0000 400 4903 MIN ORDER: 1	\$409.00
SMART CONNECTOR 2 A		CA01 400 4900 MIN ORDER: 1	\$60.00				

FUELS & 2-STROKE OILS

		VOLUME	ORDER NUMBER	MIN ORDER	RRP INC. GST
MOTOMIX® MotoMix®		1L	7004 874 0102	16	\$14.00
		4L	7004 874 0103	16	\$45.00
		60L	7004 874 0104	1	\$602.00
		205L	7004 874 0105	1	\$1,622.00
2-STROKE HP Mineral oil based		100ML	0781 319 8401	10	\$5.00
		1L	0781 319 8411	10	\$31.00
		5L	0781 319 8433	4	\$87.00
		10L	0781 319 8434	1	\$164.00
2-STROKE HP ULTRA Fully synthetic ultimate lubrication		100ML	0781 319 8613	10	\$6.00
		1L	0781 319 8061	10	\$39.00
		5L	0781 319 8063	4	\$143.00
TAP Only suitable for 60L MotoMix Drum			7004 871 0623	1	\$5.00

ENGINE OIL

		VOLUME	ORDER NUMBER	MIN ORDER	RRP INC. GST
GRADE 10W-30 RB 200 / 400 / 600 / 800		600ML	0781 309 1000	12	\$10.00

ADDITIVE

		VOLUME	ORDER NUMBER	MIN ORDER	RRP INC. GST
FUEL STABILISER Improves longevity of stored fuel		236ML	7004 881 9400	12	\$27.00

Lubrication	Cleanliness	Deposit build-up protection	Corrosion protection	Miscibility up to ethanol content of 25%®	Special features	Recommendation
-------------	-------------	-----------------------------	----------------------	---	------------------	----------------





TWO-STROKE ENGINE OILS						
HP	+	+	+	+	Yes	Good lubrication & combustion properties High-quality engine oil
HP SUPER	++	++	++	++	Yes	Low in smoke, very good miscibility Top engine oil for long service life
HP ULTRA	+++	+++	+++	+++	Yes	Biodegradable, ash-free burning The best STIHL engine oil for cleanliness & long engine service life

+ SUITABLE

++ VERY SUITABLE

+++ HIGHLY SUITABLE

BAR & CHAIN OILS & ACCESSORIES





	VOLUME	ORDER NUMBER	MIN ORDER	RRP INC. GST
CHAIN & BAR FORESTPLUS Mineral oil Reliable lubrication 	1L	0781 516 6001	12	\$12.00
	5L	0781 516 6002	4	\$42.00
	20L	0781 516 6006	1	\$148.00
	200L	0781 516 6003	1	\$1,041.00
CHAIN & BAR SYNTHPLUS Semi-synthetic High performance 	1L	0781 516 2000	10	\$13.00
	5L	0781 516 2002	4	\$43.00
	20L	0781 516 2004	1	\$153.00
	200L	0781 516 2006	1	\$1,255.00
CHAIN & BAR BIOPLUS Eco-friendly Biodegradable 	1L	0781 516 3001	10	\$13.00
	5L	0781 516 3004	4	\$46.00
	20L	0781 516 3007	1	\$159.00
	COMING SOON 200L	0781 516 3010	1	\$1,499.00
CHAIN & BAR HEAVY DUTY PLUS For use in harsh conditions 	1L	7004 871 0396	12	\$23.00
	5L	7004 871 0397	4	\$77.00
	20L	7004 871 0052	1	\$225.00
OIL TAP 20L DRUMS Easy oil dispensing Does not suit ForestPlus 20L 	20L	0000 881 0119	1	\$21.00

	Base oils	Lubrication	Special features	Shelf life	Free-flowing in the cold up to...
CHAIN OILS					
FORESTPLUS	Mineral	Good	-	3 years	-15 °C
SYNTHPLUS	Synthetic & mineral	Very good	High-performance	7 years	-25 °C
BIOPLUS	Plant-based	Very good	Environmentally-friendly, biodegradable	4 years	-20 °C
HEAVY DUTY PLUS	Synthetic & mineral	Very good	Thick formula for woolly bark & hard timber	7 years	-20 °C





CANISTERS

		VOLUME	ORDER NUMBER	MIN ORDER	RRP INC. GST
FUEL CAN		5L	7004 872 1743	6	\$19.00
MIXING BOTTLE		1L	0000 881 9411	10	\$12.00

LUBES

		VOLUME	ORDER NUMBER	MIN ORDER	RRP INC. GST
BIO MULTI USE OIL Natural oil base		50ML	0782 516 8500	15	\$12.00
MULTIPURPOSE GREASE		80G	0781 120 1109	10	\$23.00
		225G	0781 120 1110	1	\$42.00
SUPERLUB FS / BT 45 / MM 55 / MM 56 / FH / HL High performance gear lube		80G	0781 120 1117	10	\$23.00
		225G	0781 120 1118	1	\$44.00
MULTISPRAY Multi-purpose lubricant		400ML	7004 871 0437	6	\$19.00

CLEANERS

		VOLUME	ORDER NUMBER	MIN ORDER	RRP INC. GST
VARIOCLEAN ECO Desolves & removes organic residue. Made from 92% natural ingredients		500ML	0782 516 8006	1	\$24.00
VARIOCLEAN Desolves & removes organic residue		5L Commercial/Workshop use only - not for retail sale	7004 516 0003	2	\$56.00
MULTICLEAN RMI & RMA		500ML	0782 516 8200	1	\$37.00
SUPERCLEAN Lubricates & removes resin & dirt		300ML	7004 871 0438	6	\$18.00

CHAINSAW PROTECTIVE PANTS

	SIZE	ORDER NUMBER	RRP INC. GST
FUNCTION CORE TROUSERS 	XS	0088 342 2902	
	S	0088 342 2903	
	M	0088 342 2904	
	L	0088 342 2905	\$179.00 MIN ORDER: 1
	XL	0088 342 2906	
	XXL	0088 342 2907	
	XXXL	0088 342 2908	

	SIZE	ORDER NUMBER	RRP INC. GST
ADVANCED X-FLEX 	XS	0088 342 1202	
	S	0088 342 1203	
	M	0088 342 1204	
	L	0088 342 1205	\$459.00 MIN ORDER: 1
	XL	0088 342 1206	
	XXL	0088 342 1207	
	XXXL	0088 342 1208	

	SIZE	ORDER NUMBER	RRP INC. GST
FUNCTION ERGO TROUSERS 	XS	0088 342 1002	
	S	0088 342 1003	
	M	0088 342 1004	
	L	0088 342 1005	\$250.00 MIN ORDER: 1
	XL	0088 342 1006	
	XXL	0088 342 1007	

	SIZE	ORDER NUMBER	RRP INC. GST
ADVANCED X-LIGHT 	S	0088 342 1403	
	M	0088 342 1404	
	L	0088 342 1405	\$378.00 MIN ORDER: 1
	XL	0088 342 1406	
	XXL	0088 342 1407	
	XXXL	0088 342 1408	

	SIZE	ORDER NUMBER	RRP INC. GST
G&U NAVY 	S	7004 884 6904	
	M	7004 884 6905	
	L	7004 884 6906	\$521.00 MIN ORDER: 1
	XL	7004 884 6907	

	SIZE	ORDER NUMBER	RRP INC. GST
G&U ORANGE 	S	7004 884 6900	
	M	7004 884 6901	
	L	7004 884 6902	\$521.00 MIN ORDER: 1
	XL	7004 884 6903	

CHAINSAW PROTECTIVE CHAPS



	SIZE	ORDER NUMBER	RRP INC. GST
PROFESSIONAL 	S	7004 885 2106	
	M	7004 885 2107	\$312.00 MIN ORDER: 1
	L	7004 885 2108	

	SIZE	ORDER NUMBER	RRP INC. GST
G&U ORANGE 	S	7004 885 2103	
	M	7004 885 2104	\$475.00 MIN ORDER: 1
	L	7004 885 2105	

	SIZE	ORDER NUMBER	RRP INC. GST
FUNCTION CORE 270 	XS	0088 521 0401	
	S	0088 521 0402	
	M	0088 521 0403	\$179.00 MIN ORDER: 1
	L	0088 521 0404	
	XL	0088 521 0405	

	SIZE	ORDER NUMBER	RRP INC. GST
G&U NAVY 	S	7004 885 2100	
	M	7004 885 2101	\$475.00 MIN ORDER: 1
	L	7004 885 2102	



WORK PANTS

	SIZE	ORDER NUMBER	RRP INC. GST		SIZE	ORDER NUMBER	RRP INC. GST	
FS PROTECT GREEN While stocks last 	XS	0000 888 6244	\$169.00 MIN ORDER: 1	FS TRI PROTECT PANTS While stocks last 	XS	0000 884 9444	\$199.00 MIN ORDER: 1	
	S	0000 888 6248				S		0088 458 0103
FS PROTECT - HI VIS ORANGE While stocks last 	XS	0000 888 6144	\$194.00 MIN ORDER: 1		XXL	0088 458 0107		
	S	0000 888 6148						
	M	0000 888 6152						
	L	0000 888 6156						
	XL	0000 888 6160						





PROTECTIVE INSERTS

	ORDER NUMBER	RRP INC. GST
LEG PROTECTION FS, FS 3 PROTECT & HS MULTI-PROTECT 	0000 885 1801	\$50.00 MIN ORDER: 1





BELTS

	ORDER NUMBER	RRP INC. GST		ORDER NUMBER	RRP INC. GST
TAN LEATHER BELT (40mm) 	0000 881 0600	\$41.00 MIN ORDER: 1	BLACK LEATHER BELT (40mm) 	0000 881 0602	\$41.00 MIN ORDER: 1



BRACES



	ORDER NUMBER	RRP INC. GST		ORDER NUMBER	RRP INC. GST
FS, FS 3 PROTECT & HS MULTI-PROTECT 	0000 884 1593	\$56.00 MIN ORDER: 1	BUTTONS 	7004 871 0484	\$67.00 MIN ORDER: 1
CLIPS 	0000 884 1512	\$61.00 MIN ORDER: 1	PRO BUTTON-ON SUSPENDERS 	0000 884 1579	\$80.00 MIN ORDER: 1

FUNCTION TROUSERS

	Order number	Sizes (99 = made-to-measure)	Colour	Meets AS/NZS Safety Standards	Number of layers
	FUNCTION CORE TROUSERS	0088 342 2902 XS	● ● ●	●	-
	0088 342 2903 S				
	0088 342 2904 M				
	0088 342 2905 L				
	0088 342 2906 XL				
	0088 342 2907 XXL				
	0088 342 2908 XXXL				
	FUNCTION ERGO TROUSERS	0088 342 1002 XS	● ● ●		9
	0088 342 1003 S				
	0088 342 1004 M				
	0088 342 1005 L				
	0088 342 1006 XL				
	0088 342 1007 XXL				
		GOVERNMENT & UTILITY TROUSERS			
7004 884 6905 M					
7004 884 6906 L					
7004 884 6907 XL		●	●	6	
7004 884 6900 S					
7004 884 6901 M					
7004 884 6902 L					
7004 884 6903 XL					
	TRI PROTECT PANTS	0000 884 9444 XS	● ● ●	N/A	1
	While stocks last	0088 458 0103 S			
		0088 458 0107 XXL			

ADVANCE SERIES

	ADVANCE X-SHELL JACKETS	0088 335 1203 S	● ●	-	-
	0088 335 1204 M				
	0088 335 1205 L				
	0088 335 1206 XL				
	0088 335 1207 XXL				
	ADVANCE X-LIGHT TROUSERS	0088 342 1403 S	●	+	6
	0088 342 1404 M				
	0088 342 1405 L				
	0088 342 1406 XL				
	ADVANCE X-FLEX TROUSERS	0088 342 1408 XXL	● ●	+	6
	0088 342 1202 XS				
	0088 342 1203 S				
	0088 342 1204 M				
	0088 342 1205 L				
	0088 342 1206 XL				
	0088 342 1208 XXL				

	FUNCTION FRONT LEG PROTECTION	0088 521 0301 Length 85 cm	● ● ●	+	6
	0088 521 0302 Length 90 cm				
	0088 521 0303 Length 95 cm				
	0088 521 0304 Length 100 cm				
	0088 521 0305 Length 105 cm				
	PROFESSIONAL PROTECTIVE CHAPS	7004 885 2106 Short	● ● ●	●	6
	7004 885 2107 Regular				
	7004 885 2108 Tall				
	GOVERNMENT & UTILITY CHAPS	7004 885 2100 Short	●	●	6
	7004 885 2101 Regular				
	7004 885 2102 Tall				
	7004 885 2103 Short	●	●	6	
	7004 885 2104 Regular				
	7004 885 2105 Tall				

Approx weight (kg) for size 52	Cut protection developed exclusively for STIHL	Elastic waistband	Ventilation openings / ventilation zips / special ventilation material	Buttons for braces ^① / loops for braces	Slim fit / regular fit	Elastic outer fabric / elastic inserts / inserts made of ProElast	Durability of outer fabric	Resistance to dirt & water	Breathability	Low temperature protection	UV protection factor EN 13758-2 / UV standard 801	Quality mark 	Material
1.2	-	-	●/-/●	-/●	-/●	-/●/-	++	●	++	+	-	●	Dark Sea, high-visibility orange: 100% polyester Lining: 100% polyester
1.4	●	●	-/●/-	-/-	-/●	-/●/-	++	-	++	+	-/60	-/●/-	Outer fabric: 65% polyester, 35% cotton High-visibility orange: 70% polyester, 30% cotton Lining: 100% polyester
-	-	●	-	-	-/●	-	++	-	+	+	-	●	Outer navy: 88% cotton, 12% nylon, FR treated Lining: 100% cotton, FR treated Outer: high-visibility orange 88% cotton, 12% nylon, FR treated Lining: 100% cotton, FR treated
-	-	●	-	-	-/●	-	++	-	+	+	-	●	Outer fabric: 88% cotton, 12% nylon, FR treated Lining: 100% cotton, FR treated Outer: high-visibility orange 88% cotton, 2% nylon, FR treated Lining: 100% cotton, FR treated
-	-	-	-	-	-	-	-	-	-	-	-	-	Outer fabric: 100% polyester Membranes: polyurethane
-	-	-	-	-	-	-	-	-	-	-	-	-	Outer fabric: 75% polyester, 20% polyamide, 5% polyurethane Lining: 100% polyester
-	-	-	-	-	-	-	-	-	-	-	-	-	Outer fabric: 89% polyester, 11% elastane Lining: 100% polyester
-	-	-	-	-	-	-	-	-	-	-	-	-	Outer fabric: 65% polyester, 35% cotton High-visibility orange: 85% polyester, 15% cotton
-	●	-	-	-	-/●	-	+++	●	+	-	-	●	Outer fabric: 100% nylon, PU coated Lining: 65% polyester, 35% cotton
-	-	-	-	-	-/●	-	++	-	+	-	-	●	Outer fabric: 88% cotton, 12% nylon, FR treated Lining: 88% cotton, 12% nylon, FR treated
-	-	-	-	-	-/●	-	++	-	+	-	-	●	Outer fabric: 88% cotton, 12% nylon, FR treated Lining: 88% cotton, 12% nylon, FR treated

● AVAILABLE
- NOT AVAILABLE

+ GOOD
++ VERY GOOD
+++ EXCELLENT

① PLEASE USE BRACES WITH CLIPS FOR MODELS WITHOUT BUTTONS

WORK JACKETS

	SIZE	ORDER NUMBER	RRP INC. GST
ADVANCE X-SHELL 	S	0088 335 1203	
	M	0088 335 1204	
	L	0088 335 1205	\$347.00 MIN ORDER: 1
	XL	0088 335 1206	
	XXL	0088 335 1207	

	SIZE	ORDER NUMBER	RRP INC. GST
DUROFLEX 	S	0088 554 0203	
	M	0088 554 0204	
	L	0088 554 0205	\$159.00 MIN ORDER: 1
	XL	0088 554 0206	
	XXL	0088 554 0207	

THERMAL UNDERGARMENTS

	SIZE	ORDER NUMBER	RRP INC. GST
ADVANCE FUNCTION LONG SLEEVE 	S	0000 888 6048	
	M	0000 888 6052	
	L	0000 888 6056	\$123.00 MIN ORDER: 1
	XL	0000 888 6060	
	XXL	0000 888 6064	

	SIZE	ORDER NUMBER	RRP INC. GST
ADVANCE FUNCTION SHORT SLEEVE 	S	0088 585 0048	
	M	0088 585 0052	
	L	0088 585 0056	\$77.00 MIN ORDER: 1
	XL	0088 585 0060	
	XXL	0088 585 0064	



	SIZE	ORDER NUMBER	RRP INC. GST
ADVANCE FUNCTION PANTS 	S	0000 888 5948	
	M	0000 888 5952	
	L	0000 888 5956	\$82.00 MIN ORDER: 1
	XL	0000 888 5960	
	XXL	0000 888 5964	

CASUAL WEAR

	SIZE	ORDER NUMBER	RRP INC. GST
T-SHIRT DYNAMIC MAG COOL ADVANCED BLACK 	S	0088 302 0048	
	M	0088 302 0052	
	L	0088 302 0056	\$41.00 MIN ORDER: 1
	XL	0088 302 0060	
	XXL	0088 302 0064	







	SIZE	ORDER NUMBER	RRP INC. GST
T-SHIRT DYNAMIC MAG COOL ADVANCED ORANGE 	S	0088 302 0148	
	M	0088 302 0152	
	L	0088 302 0156	\$41.00 MIN ORDER: 1
	XL	0088 302 0160	
	XXL	0088 302 0164	

EYE PROTECTION

	ORDER NUMBER	RRP INC. GST		ORDER NUMBER	RRP INC. GST
FUNCTION LIGHT SAFETY GLASSES CLEAR 	0000 884 0361	\$14.00 MIN ORDER: 1	FUNCTION LIGHT SAFETY GLASSES GREY 	0000 884 0362	\$14.00 MIN ORDER: 1

WORK GLOVES









	SIZE	ORDER NUMBER	RRP INC. GST		SIZE	ORDER NUMBER	RRP INC. GST	
SENSOTOUCH 	M = 9	0088 611 1509	\$10.00 MIN ORDER: 1	FUNCTION UNIVERSAL 	One size	0088 611 1410	\$12.00 MIN ORDER: 1	
	L = 10	0088 611 1510						
	XL = 11	0088 611 1511						
FUNCTION DUROGRIP 	S = 8	0088 611 1008	\$21.00 MIN ORDER: 1	DYNAMIC SENSOLIGHT 	S = 8	0088 611 0808	\$31.00 MIN ORDER: 1	
	M = 9	0088 611 1009				M = 9		0088 611 0809
	L = 10	0088 611 1010				L = 10		0088 611 0810
	XL = 11	0088 611 1011				XL = 11		0088 611 0811
DYNAMIC DURO 	S = 8	0088 611 1308	\$25.00 MIN ORDER: 1	ADVANCE ERGO 	M = 9	0088 611 0409	\$44.00 MIN ORDER: 1	
	M = 9	0088 611 1309				L = 10		0088 611 0410
	L = 10	0088 611 1310				XL = 11		0088 611 0411
	XL = 11	0088 611 1311						
ADVANCE ERGO FS 	S = 8	0000 883 8503	\$80.00 MIN ORDER: 1	PROMOTIONAL GLOVE 	One size	7004 871 0572	\$10.00 MIN ORDER: 1	
	M = 9	0000 883 8504						
	XL = 11	0000 883 8506						

	Sizes	Order number	Material	Fit / cut	Sensitivity	Durability	Low temperature protection	Cuff	Special features
FUNCTION SERIES									
PROTECTIVE GLOVES									
SENSOTOUCH 	M = 9	0088 611 1509	Knit with PU coating	+++	+++	++	+	Elastic	Good grip, good water protection
	L = 10	0088 611 1510							
	XL = 11	0088 611 1511							
UNIVERSAL FUNCTION 	Universal size	0088 611 1410	Cowskin leather / canvas back	+	+	++	+	Open cuff	Long cuff
DUROGRIP FUNCTION 	S = 8	0088 611 1008	Knit with latex dipping	++	+	+++	++	Elastic	Good (wet) grip, good water protection
	M = 9	0088 610 0109							
	L = 10	0088 611 0110							
	XL = 11	0088 611 0111							
DYNAMIC SERIES									
PROTECTIVE GLOVES									
DYNAMIC DURO 	S = 8	0088 611 1308	Cowskin leather	++	+	+++	+	Open cuff	All-round leather
	M = 9	0088 611 1309							
	L = 10	0088 611 1310							
	XL = 11	0088 611 1311							
DYNAMIC SENSOLIGHT 	S = 8	0088 611 0808	Sheepskin leather / textile back	++	+++	++	+	Elastic, velcro fastener	Reflective strips, light
	M = 9	0088 611 0809							
	L = 10	0088 611 0810							
	XL = 11	0088 611 0811							
ADVANCE SERIES									
ADVANCE ERGO 	M = 9	0088 611 0409	Sheepskin leather / textile back	+++	+++	++	+	Elastic, velcro fastener	Reflective strips
	L = 10	0088 611 0410							
	XL = 11	0088 611 0411							
ADVANCE ERGO FS 	S = 8	0000 883 8503	Cowskin leather	+++	++	+++	+	Velcro fastener	Reflective strips, impact protection
	M = 9	0000 883 8504							
	XL = 11	0000 883 8506							





HEAD PROTECTION

		ORDER NUMBER	RRP INC. GST			ORDER NUMBER	RRP INC. GST
X-VENT HELMET		7004 884 0109	\$148.00 MIN ORDER: 1	FUNCTION BASIC HELMET		7004 888 0800	\$82.00 MIN ORDER: 1
X-VENT VISOR HOLDER		0000 889 9013	\$38.00 MIN ORDER: 1	FUNCTION BASIC EARMUFFS		0000 889 9019	\$38.00 MIN ORDER: 1
X-VENT SHORT PEAK VISOR		0000 889 9011	\$21.00 MIN ORDER: 1	NYLON MESH VISOR Suits Function Basic & X-Vent		0000 889 9028	\$31.00 MIN ORDER: 1
X-VENT HELMET INTERIOR Complete with IFU		0000 889 9008	\$56.00 MIN ORDER: 1	FUNCTION BASIC VISOR HOLDER		0000 889 9042	\$31.00 MIN ORDER: 1
X-VENT EAR MUFFS		7004 888 0200	\$61.00 MIN ORDER: 1	FUNCTION BASIC CHIN STRAP		0000 889 8003	\$18.50 MIN ORDER: 1
X-VENT S/S MESH VISOR		7004 888 0300	\$56.00 MIN ORDER: 1	POLY VISOR WITH EARMUFFS		0000 884 0253	\$113.00 MIN ORDER: 1
X-VENT CHIN STRAP		0000 889 8007	\$35.00 MIN ORDER: 1	REPLACEMENT POLY VISOR Suits 0000 884 0253		0000 889 9025	\$42.00 MIN ORDER: 1
X-VENT HYGIENE KIT		0000 889 9009	\$36.00 MIN ORDER: 1	POLY FACE SHIELD WITH HEARING PROTECTION		0000 884 0255	\$61.00 MIN ORDER: 1
X-VENT HELMET INTERIOR Suits updated helmet with Version 2 sticker only		0000 889 9052	\$34.00 MIN ORDER: 1	MESH FACE SHIELD WITH HEARING PROTECTION		0000 884 0252	\$66.00 MIN ORDER: 1
X-VENT HELMET SWEATBAND Suits updated helmet with Version 2 sticker only		0000 889 9053	\$14.00 MIN ORDER: 1	MESH VISOR WITH EARMUFFS		0000 884 0254	\$113.00 MIN ORDER: 1

New Sweatband is NOT compatible with the previous version of X-VENT Helmet or Interior. Both Interior and Sweatband must be replaced together to be compatible with previous X-VENT Helmet version. The revised Helmet can be easily be identified by the "Ver 2" sticker inside.

		ORDER NUMBER	RRP INC. GST			ORDER NUMBER	RRP INC. GST
STIHL ADVANCE PROCOM OVERHEAD EARMUFFS 		0000 884 0544	\$599.00 MIN ORDER: 1	DYNAMIC BT EARMUFFS  <ul style="list-style-type: none"> - Bluetooth music streaming - Answer phone calls - Overhead - Medium noise 		0000 884 0519	\$230.00 MIN ORDER: 1
STIHL ADVANCE PROCOM HELMET MOUNT EARMUFFS  <p>Suits Advance X-vent (additional adapter required for Function Basic - see Academy for fitment instructions)</p>		0000 889 8011	\$599.00 MIN ORDER: 1	BT HEADPHONE CHARGING CABLE 		0000 889 8005	\$23.00 MIN ORDER: 1
ADVANCE PROCOM HYGIENE KIT 		0000 889 9047	\$20.57 MIN ORDER: 1	STIHL TIMBERSPORTS® EARMUFFS 		0000 884 0546	\$55.00 MIN ORDER: 1
PROCOM HELMET MOUNTED EARMUFF ADAPTERS  <p>Required to fit Function Basic (Not required for X-Vent)</p>		0000 889 8013	\$40.00 MIN ORDER: 1	STIHL TIMBERSPORTS® EARMUFF HYGIENE KIT 		0000 889 9038	\$27.00 MIN ORDER: 1

SHEARS & TRIMMER

	ORDER NUMBER	RRP INC. GST		ORDER NUMBER	RRP INC. GST
BYPASS SHEARS - PB 10 - 60cm length - 35mm cut diameter	0000 881 3669	\$92.00 MIN ORDER: 1		ANVIL SHEARS - PB 25 - 80cm length - 40mm cut diameter	0000 881 3653 \$153.00 MIN ORDER: 1
BYPASS SHEARS - PB 11 - 75cm length - 35mm cut diameter	0000 881 3670	\$113.00 MIN ORDER: 1		ANVIL SHEARS - PB 35 - 80cm length with hook - 48mm cut diameter	0000 881 3665 \$220.00 MIN ORDER: 1
BYPASS SHEARS - PB 20 - 80cm length - 42mm cut diameter	0000 881 3664	\$164.00 MIN ORDER: 1		ANVIL SHEARS - Felco F231 - 80cm length - 40mm cut diameter While stocks last	0000 881 3679 \$337.00 MIN ORDER: 1
BYPASS SHEARS - PB 30 - 83cm length - 50mm cut diameter	0000 881 6500	\$205.00 MIN ORDER: 1		HEDGE TRIMMER - PH 10 - 54cm length	0000 881 3671 \$113.00 MIN ORDER: 1

SECATEURS

	ORDER NUMBER	RRP INC. GST		ORDER NUMBER	RRP INC. GST
BYPASS SECATEURS PG 10 - Entry level	0000 881 3604	\$25.00 MIN ORDER: 6		BYPASS SECATEURS FELCO F 9 - Ergonomic - Left-handed	0000 881 8504 \$123.00 MIN ORDER: 1
BYPASS SECATEURS PG 20 - Universal	0000 881 3637	\$56.00 MIN ORDER: 1		BYPASS SECATEURS FELCO F 2 - Universal	0000 881 8500 \$113.00 MIN ORDER: 1
BYPASS SECATEURS PG 30 - Professional - Universal	0000 881 3638	\$92.00 MIN ORDER: 1		BYPASS SECATEURS FELCO F 6 - Compact	0000 881 8501 \$113.00 MIN ORDER: 1
ANVIL SECATEURS PG 25 - Universal	0000 881 3639	\$61.00 MIN ORDER: 1		BYPASS SECATEURS FELCO F 7 - Revolving handle - Comfortable	0000 881 8502 \$143.00 MIN ORDER: 1
BYPASS SECATEURS FELCO F 8 - Ergonomic	0000 881 8503	\$113.00 MIN ORDER: 1		HAND TOOL SHARPENER 3-IN-1	0000 881 9801 \$36.00 MIN ORDER: 1
SECATEURS ACCESSORY Leather holster	0000 881 3644	\$34.00 MIN ORDER: 1			



PRUNING SAWS

	ORDER NUMBER	RRP INC. GST		ORDER NUMBER	RRP INC. GST
PR 16 FOLDING 16CM	0000 881 8700	\$61.00 MIN ORDER: 1		PR 33 C 33CM - CURVED	0000 881 8704 \$148.00 MIN ORDER: 1
				REPLACEMENT BLADE	0000 881 9931 \$103.00 MIN ORDER: 1
				PR 27 C 27CM CURVED	0000 881 8703 \$153.00 MIN ORDER: 1
				REPLACEMENT BLADE	0000 881 9930 \$92.00 MIN ORDER: 1

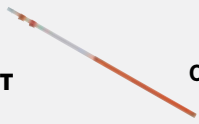







TELESCOPIC PRUNING SAW

	ORDER NUMBER	RRP INC. GST		ORDER NUMBER	RRP INC. GST
TELESCOPIC ROD PR 40 CT	0000 881 4113	\$347.00 MIN ORDER: 1		PRUNING SAW Fits PR 40 CT	0000 881 4141 \$235.00 MIN ORDER: 1

AXES AND HIT HATCHET - GLASS FIBRE REINFORCED

	ORDER NUMBER	RRP INC. GST		ORDER NUMBER	RRP INC. GST
AX 6 P 640G 	0000 881 6801	\$113.00 MIN ORDER: 1	AX 20 PC 1950G 	0000 881 6602	\$205.00 MIN ORDER: 1
AX 15 P 	0000 881 6701	\$148.00 MIN ORDER: 1			







AXES & SPLITTING HAMMER - CLASSIC

	ORDER NUMBER	RRP INC. GST		ORDER NUMBER	RRP INC. GST
AX 6 600G 	0000 881 1969	\$67.00 MIN ORDER: 1	AX 28 CS 2800G 	0000 881 2014	\$153.00 MIN ORDER: 1
REPLACEMENT HANDLE 40CM 	0000 881 2152	\$16.00 MIN ORDER: 1	REPLACEMENT HANDLE 70CM 	0000 881 2146	\$83.00 MIN ORDER: 1
AX 10 1000G 	0000 881 1971	\$87.00 MIN ORDER: 1	SPLITTING HAMMER AX 33 CS 3300G 	0000 881 2011	\$179.00 MIN ORDER: 1
REPLACEMENT HANDLE 60CM 	0000 881 2153	\$38.00 MIN ORDER: 1	REPLACEMENT HANDLE 90CM 	0000 881 2012	\$67.00 MIN ORDER: 1



AXES - TRADITIONAL 1926 REPLACEMENT HANDLES

	ORDER NUMBER	RRP INC. GST
AX 7 REPLACEMENT HANDLE 40CM 	0000 881 2149	\$61.00 MIN ORDER: 1

FORESTRY TOOLS



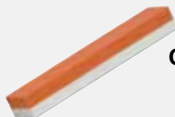







	ORDER NUMBER	RRP INC. GST		ORDER NUMBER	RRP INC. GST
REPLACEMENT CANT HOOK SPIKE Spike not pictured 	0000 881 2615	\$56.00 MIN ORDER: 1	HAND LIFTING TONGS FP 20 	0000 881 3005	\$87.00 MIN ORDER: 1
FELLING LEVER 76CM 1800G 	0000 881 2701	\$159.00 MIN ORDER: 1	PULP HOOK FP 10 	0000 881 4401	\$61.00 MIN ORDER: 1
FELLING LEVER 130CM 3400G 	0000 881 2700	\$240.00 MIN ORDER: 1	DRAG HOOK FZ 10 	0000 881 2907	\$82.00 MIN ORDER: 1

SHARPENERS

	ORDER NUMBER	RRP INC. GST		ORDER NUMBER	RRP INC. GST
HAND TOOL SHARPENER Sharpening stone & whetstone 	0000 881 6001	\$28.00 MIN ORDER: 1	HAND TOOL SHARPENER 3-IN-1 	0000 881 9801	\$36.00 MIN ORDER: 1











i FOR REPLACEMENT HAND TOOL COMPONENTS, PLEASE REFER TO SSC

STIHL TIMBERSPORTS® CLOTHING

	SIZE	ORDER NUMBER	RRP INC. GST		SIZE	ORDER NUMBER	RRP INC. GST
T-SHIRT TIMBERSPORTS® AXE BLACK 	S	0421 301 2348	\$45.00 MIN ORDER: 1	T-SHIRT TIMBERSPORTS® AXE WHITE 	S	0421 301 2248	\$45.00 MIN ORDER: 1
	M	0421 301 2352			M	0421 301 2252	
	L	0421 301 2356			L	0421 301 2256	
	XL	0421 301 2360			XL	0421 301 2260	
	XXL	0421 301 2364			XXL	0421 301 2264	
	XXXL	0421 301 2368			XXXL	0421 301 2268	
HOODIE TIMBERSPORTS® 85 RETRO 	S	0421 400 4448	\$115.00 MIN ORDER: 1	HOODIE LOGO TIMBERSPORTS® GREY 	S	0421 400 2948	\$86.00 MIN ORDER: 1
	M	0421 400 4452			M	0421 400 2952	
	L	0421 400 4456			L	0421 400 2956	
	XL	0421 400 4460			XL	0421 400 2960	
	XXL	0421 400 4464			XXL	0421 400 2964	
	XXXL	0421 400 4468			XXXL	0421 400 2968	
SWEATSHIRT LOGO TIMBERSPORTS® GREY 	S	0421 300 7548	\$75.00 MIN ORDER: 1	SPORTS LEGGINGS LONG TIMBERSPORTS® WOMENS BLACK 	S	0421 222 1538	\$62.00 MIN ORDER: 1
	M	0421 300 7552			M	0421 222 1542	
	L	0421 300 7556			L	0421 222 1546	
	XL	0421 300 7560			XL	0421 222 1550	
	XXL	0421 300 7564					
	XXXL	0421 300 7568					
TIMBERSPORTS T-SHIRT SCRATCHED AXE BLACK 	S	0421 300 1148	\$45.00 MIN ORDER: 1	TIMBERSPORTS KID'S T-SHIRTS 	110-116	0421 300 2616	\$30.00 MIN ORDER: 1
					122-128	0421 300 2628	
					134-140	0421 300 2640	
JACKET TIMBERSPORTS® LOGO BLACK 	S	0421 100 3048	\$112.00 MIN ORDER: 1	TIMBERSPORTS MEN'S PERFORMANCE TOP 	M	0421 300 1252	\$50.00 MIN ORDER: 1
	M	0421 100 3052			XL	0421 300 1260	
	L	0421 100 3056			XXL	0421 300 1264	
	XL	0421 100 3060					
	XXL	0421 100 3064					
	XXXL	0421 100 3068					









NOTE: STOCK MAY CHANGE WITHOUT NOTICE OR BECOME UNAVAILABLE

STIHL TIMBERSPORTS® MERCHANDISE

	ORDER NUMBER	RRP INC. GST		ORDER NUMBER	RRP INC. GST
CAP TIMBERSPORTS® 85 RETRO 	0421 600 0254	\$40.00 MIN ORDER: 1	CAP WHITE AXE White 	0421 600 0236	\$30.00 MIN ORDER: 1
SHOELACES 2-PACK TIMBERSPORTS® 	0421 600 0211	\$13.00 MIN ORDER: 1	CAP TIMBERSPORTS® LOGO BLACK 	0421 600 0213	\$15.00 MIN ORDER: 1
TIMBERSPORTS® AXE MUG Black/White 	0421 600 0072	\$26.00 MIN ORDER: 1	CAP PATTERN TIMBERSPORTS® 	0421 600 0203	\$26.00 MIN ORDER: 1
CHRISTMAS TREE ORNAMENT 	0421 600 0077	\$27.00 MIN ORDER: 1	CAP KIDS PATTERN TIMBERSPORTS® GREY 	0421 600 0208	\$24.00 MIN ORDER: 1
SOCKS CAMOUFLAGE TIMBERSPORTS® 	35-38 0421 500 1838 <hr/> 39-42 0421 500 1842 <hr/> 43-46 0421 500 1846	\$19.00 MIN ORDER: 1	AXE CAP Black - Grey Axes 	0420 540 0013	\$35.00 MIN ORDER: 1

NOTE: STOCK MAY CHANGE WITHOUT NOTICE OR BECOME UNAVAILABLE

CLOTHING

	SIZE	ORDER NUMBER	RRP INC. GST		SIZE	ORDER NUMBER	RRP INC. GST
FLEECE JACKET STIHL CLASSIC BLACK Black 	S	0421 100 4748	\$65.00 MIN ORDER: 1	FLEECE JACKET STIHL CLASSIC ORANGE Orange 	S	0421 100 4848	\$65.00 MIN ORDER: 1
	M	0421 100 4752			M	0421 100 4852	
	L	0421 100 4756			L	0421 100 4856	
	XL	0421 100 4760			XL	0421 100 4860	
	XXL	0421 100 4764			XXL	0421 100 4864	
	XXXL	0421 100 4768			XXXL	0421 100 4868	
FLEECE JACKET STIHL CLASSIC KIDS ORANGE Orange 	98-104	0421 100 5504	\$50.00 MIN ORDER: 1	SHIRT PLAID FLANNEL COSY Brown 	S	0421 400 4248	\$80.00 MIN ORDER: 1
	110-116	0421 100 5516			M	0421 400 4252	
	122-128	0421 100 5528			L	0421 400 4256	
	134-140	0421 100 5540			XL	0421 400 4260	
	146-152	0421 100 5552			XXL	0421 400 4264	
POLO SHIRT BASIC ORANGE Orange 	S	0421 301 1548	45.00 MIN ORDER: 1	POLO SHIRT BASIC BLUE Blue 	S	0421 301 1748	45.00 MIN ORDER: 1
	M	0421 301 1552			M	0421 301 1752	
	L	0421 301 1556			L	0421 301 1756	
	XL	0421 301 1560			XL	0421 301 1760	
	XXL	0421 301 1564			XXL	0421 301 1764	
WOMENS POLO SHIRT BASIC GREEN Green 	S	0421 301 1938	\$45.00 MIN ORDER: 1	WOMENS POLO SHIRT BASIC GREY Grey 	S	0421 301 2038	\$45.00 MIN ORDER: 1
	M	0421 301 1942			M	0421 301 2042	
	L	0421 301 1946			L	0421 301 2046	
	XL	0421 301 1950			XL	0421 301 2050	
	T-SHIRT LEGENDARY CONTRA White 	S			0421 301 2848	\$55.00 MIN ORDER: 1	
M		0421 301 2852	M	0421 301 3552			
L		0421 301 2856	L	0421 301 3556			
XL		0421 301 2860	XL	0421 301 3560			
XXL		0421 301 2864	XXL	0421 301 3564			
XXXL		0421 301 2868	XXXL	0421 301 3568			

NOTE: STOCK MAY CHANGE WITHOUT NOTICE OR BECOME UNAVAILABLE

**HOODIE
LEGENDARY**

Grey



SIZE	ORDER NUMBER	RRP INC. GST
S	0421 400 2748	
M	0421 400 2752	
L	0421 400 2756	\$100.00 MIN ORDER: 1
XL	0421 400 2760	
XXL	0421 400 2764	
XXXL	0421 400 2768	

**T-SHIRT
MS 500i
BACK**

Black



SIZE	ORDER NUMBER	RRP INC. GST
S	0421 300 8048	
M	0421 300 8052	
L	0421 300 8056	\$38.00 MIN ORDER: 1
XL	0421 300 8060	
XXL	0421 300 8064	
XXXL	0421 300 8068	

**SWEATPANTS
LEGENDARY**

Grey



SIZE	ORDER NUMBER	RRP INC. GST
S	0421 222 1348	
M	0421 222 1352	
L	0421 222 1356	\$89.00 MIN ORDER: 1
XL	0421 222 1360	
XXL	0421 222 1364	
XXXL	0421 222 1368	

**T-SHIRT
KIDS**

Grey



SIZE	ORDER NUMBER	RRP INC. GST
98-104	0421 300 9104	
110-116	0421 300 9116	
122-128	0421 300 9128	\$32.00 MIN ORDER: 1
135-140	0421 300 9140	
146-152	0421 300 9152	

**OVERALL
KIDS**

Green



SIZE	ORDER NUMBER	RRP INC. GST
98-104	0421 222 2104	
110-116	0421 222 2116	
122-128	0421 222 2128	\$75.00 MIN ORDER: 1
135-140	0421 222 2140	
146-152	0421 222 2152	

**T-SHIRT
KIDS**

Orange



SIZE	ORDER NUMBER	RRP INC. GST
98-104	0421 300 9204	
122-128	0421 300 9228	\$32.00 MIN ORDER: 1
135-140	0421 300 9240	
146-152	0421 300 9252	

SWEATSHIRT SIGN

Black



SIZE	ORDER NUMBER	RRP INC. GST
XL	0420 200 2360	\$89.00 MIN ORDER: 1

**SWEATSHIRT
SMALL LOGO**

Green





SIZE	ORDER NUMBER	RRP INC. GST
S	0421 300 5848	
M	0421 300 5852	
L	0421 300 5856	\$61.00 MIN ORDER: 1
XL	0421 300 5860	
XXL	0421 300 5864	
XXXL	0421 300 5868	

CLOTHING CONTINUED





	SIZE	ORDER NUMBER	RRP INC. GST		SIZE	ORDER NUMBER	RRP INC. GST
SWEATSHIRT LOGO UNISEX Black 	S	0421 300 4848	\$62.00 MIN ORDER: 1	HOODIE COLORBLOCK SLEEVE Green 	S	0421 400 1348	\$86.00 MIN ORDER: 1
	M	0421 300 4852			M	0421 400 1352	
	L	0421 300 4856			L	0421 400 1356	
	XL	0421 300 4860			XL	0421 400 1360	
	XXL	0421 300 4864			XXL	0421 400 1364	
	XXXL	0421 300 4868			XXXL	0421 400 1368	
UNISEX HOODIE JACKET STIHL Black 	S	0421 100 2548	\$62.00 MIN ORDER: 1	UNISEX HOODIE COLORBLOCK POCKET Green 	S	0421 400 1448	\$86.00 MIN ORDER: 1
	XL	0421 100 2560			M	0421 400 1452	
	XXL	0421 100 2564			XXL	0421 400 1464	
	XXXL	0421 100 2568					
MEN'S T-SHIRT AXE OVERSIZED Black 	M	0421 300 4752	\$37.00 MIN ORDER: 1	MEN'S SWEATSHIRT SMALL AXE Dark grey 	M	0421 300 5752	\$74.00 MIN ORDER: 1
	L	0421 300 4756			L	0421 300 5756	
	XL	0421 300 4760			XL	0421 300 5760	
	XXL	0421 300 4764			XXL	0421 300 5764	
	XXXL	0421 300 4768			XXXL	0421 300 5768	
T-SHIRT LOGO CIRCLE Orange 	S	0420 600 3748	\$35.00 MIN ORDER: 1	ICON PLUSH FLEECE JACKET 	M	0421 100 0852	\$100.00 MIN ORDER: 1
	M	0420 600 3752					
	L	0420 600 3756					
	XL	0420 600 3760					
	XXL	0420 600 3764					

NOTE: STOCK MAY CHANGE WITHOUT NOTICE OR BECOME UNAVAILABLE





CLOTHING

	SIZE	ORDER NUMBER	RRP INC. GST		SIZE	ORDER NUMBER	RRP INC. GST
PLAID SHIRT Red 	S	0421 400 0348	\$70.00 MIN ORDER: 1	HEAVY FLANNEL SHIRT Beige 	S	0421 100 0748	\$110.00 MIN ORDER: 1
	M	0421 400 0352			M	0421 100 0752	
POOL SLIDERS 	36-37	0420 950 0337	\$30.00 MIN ORDER: 1				
	38-39	0420 950 0339					







BEANIES

	ORDER NUMBER	RRP INC. GST		ORDER NUMBER	RRP INC. GST
BEANIE SIGN Orange 	0421 600 0196	\$34.00 MIN ORDER: 1	CAP POMPOM 24 Black/Orange/Grey 	0421 600 0200	\$34.00 MIN ORDER: 1
BEANIE KIDS SIGN Orange 	0421 600 0209	\$26.00 MIN ORDER: 1	CAP KIDS POMPOM 24 Black/Orange/Grey 	0421 600 0210	\$26.00 MIN ORDER: 1





CAPS

	ORDER NUMBER	RRP INC. GST		ORDER NUMBER	RRP INC. GST
CAP SIGN Grey 	0421 600 0201	\$26.00 MIN ORDER: 1	CAP LYOCELL Grey 	0421 600 0202	\$26.00 MIN ORDER: 1
FLAT CAP Grey 	Size M/57 0421 500 0557	\$40.00 MIN ORDER: 1	CAP LEGENDARY PERFORMANCE Olive / Black 	0421 600 0036	\$45.00 MIN ORDER: 1

TOYS

	ORDER NUMBER	RRP INC. GST		ORDER NUMBER	RRP INC. GST
TOY CHAINSAW 	0421 600 0053	\$69.00 MIN ORDER: 10	CHILDREN'S TOY HELMET 	0420 460 0001	\$49.00 MIN ORDER: 3
TOY BLOWER 	0420 460 0016	\$69.00 MIN ORDER: 6	KIDS 4PC GARDEN SET 	0421 600 0172	\$50.00 MIN ORDER: 1
TOY BRUSHCUTTER 	0420 460 0015	\$69.00 MIN ORDER: 8	WOODEN WORKBENCH FOR KIDS Brown/Orange 	0421 600 0144	\$199.00 MIN ORDER: 1

BAGS

	ORDER NUMBER	RRP INC. GST		ORDER NUMBER	RRP INC. GST
CARRY BAG Paper 	0420 760 0007	\$0.50 PER BAG MIN ORDER: 250	DUFFLE BAG 43x55cm 	0000 891 0820	\$3.00 PER BAG MIN ORDER: 10
CARRY BAG - JUTE Hessian 	0420 760 0008	\$8.00 PER BAG MIN ORDER: 50	OWNER'S MANUAL BAG ZIP LOCK 90 microns (um) 25x38cm 	7004 100 0101	\$0.20 PER BAG MIN ORDER: 100

NOTE: STOCK MAY CHANGE WITHOUT NOTICE OR BECOME UNAVAILABLE

MERCHANDISE

	ORDER NUMBER	RRP INC. GST		ORDER NUMBER	RRP INC. GST
SHOELACES 	0421 600 0212	\$13.00 MIN ORDER: 1	HIP FLASK CONTRA 	0421 600 0171	\$26.00 MIN ORDER: 1
CORKSCREW CHAINSAW STARTER 	0421 600 0182	\$26.00 MIN ORDER: 1	POWER SAW MULTITOOl 	0421 600 0184	\$54.00 MIN ORDER: 1
PLUSH ANIMAL MOOSE 	0421 600 0185	\$21.00 MIN ORDER: 1	AIRPODS CASE 	0421 600 0166 (Suits second generation) 0421 600 0167 (Suits third generation)	\$24.00 MIN ORDER: 1
LANYBOOK NOTEBOOK While stocks last 	0464 563 0010	\$25.00 MIN ORDER: 1	KEYRING CHAINSAW MAN 	0420 960 0002	\$2.00 MIN ORDER: 1
LUGGAGE STRAP WITH TSA LOCK 	0464 081 0020	\$20.00 MIN ORDER: 1	MS 500i MODEL 1:12 	0420 960 0001	\$39.00 MIN ORDER: 1
GARDEN GNOME 	0420 360 0010	\$33.00 MIN ORDER: 1	PAPERCLIPS PACK OF 20 ICON Orange 	0421 600 0091	\$3.00 MIN ORDER: 1
UNIVERSAL BOX "CONTRA" METAL 	0420 660 0000	\$25.00 MIN ORDER: 1	STIHL COFFEE MUG 	0464 257 0000	\$15.00 MIN ORDER: 1
BOTTLE 750ML 	0420 660 0010	\$15.00 MIN ORDER: 1	BEER GLASSES SET OF 2 	0464 767 0010	\$15.00 MIN ORDER: 1
KEY FOB CHAINSAW METAL 	0420 960 0008	\$8.00 MIN ORDER: 1	KEY FOB BOTTLE OPENER Grey/Silver 	0421 600 0070	\$6.00 MIN ORDER: 1
PIZZA CUTTER CUT-OFF MACHINE 	0420 960 0013	\$26.00 MIN ORDER: 1	THERMOS FLASK CIRCLE Black/Orange/White 	0421 600 0096	\$20.00 MIN ORDER: 1
WALL-MOUNTED BOTTLE OPENER WITH MAGNET Silver 	0421 600 0081	\$46.00 MIN ORDER: 1	BUMPER STICKER 45 x 100 cm 	0421 600 0168	\$5.00 MIN ORDER: 1

NOTE: STOCK MAY CHANGE WITHOUT NOTICE OR BECOME UNAVAILABLE

TRADING INFORMATION

STOCK RETURN POLICY

Application for return

- i. Complete a STIHL Stock Return Application (RMA) via the STIHL B2B system.
- ii. A Stock Return Authorisation or rejection will be emailed back to your store within 48 hours. It is possible that only some lines may be approved.
- iii. A Returns Label will be emailed to you when a Returns Application is approved, detailing which warehouse the goods must be shipped back to.
- iv. It is up to the dealer to organise and pay the cost of freight to return the goods to the nominated warehouse, unless STIHL has supplied incorrectly.
- v. A copy of the approved Stock Return Application must be included with the boxed goods.
- vi. The following stock return codes are to be used when creating a Stock Return Application:

A - Dealer Ordered Incorrectly; B - Dealer Duplicated Order; or C - Incorrectly Supplied by STIHL

Stock rehandling charge

All returned items, except for items supplied incorrectly, will be subject to a 15% rehandling charge. The charge is calculated on the product value.

Timeliness of return

Return Stock Applications are to be submitted to STIHL Customer Service via STIHL B2B no later than 14 days after invoice date. Applications made after 14 days may be accepted but will be subject to a 25% rehandling charge.

Stock not eligible for return

STIHL is unable to accept the return of the following stock items when they have been supplied in accordance with the dealer order:

- i. Items of original equipment, eg. chainsaws, brushcutters, etc.
- ii. Items of accessories e.g. guide bars, PPE, nylon, etc.
- iii. Oils and lubricants
- iv. Promotional items, e.g. brochures, clothing and merchandise
- v. Items which have been superseded or are no longer available at STIHL
- vi. Items that have a dealer cost of less than \$30

Condition of returned items

Items must be in as new condition with all supplied fittings and in their original, undamaged packaging showing the STIHL part number / barcode on the outside. A copy of the RMA authorisation must be included with the items being returned.

Verification of returned stock

STIHL will verify all returns to ensure correct paperwork and return requirements are met. Any items with missing or incomplete paperwork, or not in original condition, will be returned to the dealer with freight 'collect'.

Issue of Credit Note

STIHL will issue a Credit Note to the dealer's account within 5 days of the product being received in the STIHL Warehouse, providing return conditions are met.

Unauthorised returns

Any unauthorised returns will immediately be sent back to the dealer with freight 'collect'.

Goods supplied incorrectly by STIHL

STIHL will accept the return of any items incorrectly supplied, provided they are in good condition and original packaging. STIHL will accept the freight costs of these items. Please contact Customer Service in these cases.

Mispicks, short supply or oversupply of goods

If you receive a short supply, incorrect supply or oversupply of goods, please contact Customer Service within 24 hours of delivery to arrange a correction.

Goods damaged in transit

Contact Customer Service as soon as damaged goods are received. They will assist you on next steps.

WARRANTY TERMS FOR STIHL BATTERIES AND KM/MM ATTACHMENTS

PLEASE NOTE THE BELOW ENHANCEMENTS TO STIHL WARRANTY TERMS. THESE TERMS APPLY TO BATTERIES AND KM/MM ATTACHMENTS.

For further details regarding standard warranty, go to <https://www.stihl.com.au/en/warranty-information>

All batteries sold

2 year warranty on sale of domestic and farming

1 year commercial/government warranty

6 month warranty for hire companies

KM & MM attachments

1 year warranty on sale of domestic and farming

6 month commercial/government warranty

3 month warranty for hire companies



NEW GUIDE BAR DESIGN

NEW DESIGN HIGHLIGHTS:

- With the new design comes new naming
- All technical features remain unchanged
- The order number of all guide bars remains the same

OVERVIEW NEW GUIDE BAR DESIGN



Note: The printed design of the STIHL guide bars is changed. The change is made successively. During the transition period, both printed designs will occur. Until the complete conversion to the new design, the previous designation will be retained. The part numbers will not be changed.

Colours:

- Green: Green marks the products which are designed to reduce the risk of kickback injury and to comply with the ANSI B175.1 kickback standard. These products are recommended for both experienced and inexperienced chain saw users.
- Yellow: Products marked yellow indicate increased risk of kickback injury and are for use only by persons with extraordinary cutting needs and experience and specialized training for dealing with kickback.

Bar type and features:

- Light 3-piece laminated guide bar
- Light X Lightweight solid guide bar with an aluminum core and replaceable bar nose
- Strong Solid guide bar
- Carving A high quality guide bar for carving
- G Solid guide bar with water supply (for concrete cutters)
- S Solid guide bar with carbide reinforcement at the bar tip
- X Exchangeable sprocket nose
- P Lightweight guide bar with fiberglass-reinforced polyamide
- 01/04/06 Number of rivets in the sprocket nose



[STIHL.COM.AU](https://www.stihl.com.au)